

Note that all unique customer requirements (i.e tolerance) need to be verified thru Alfa Laval.

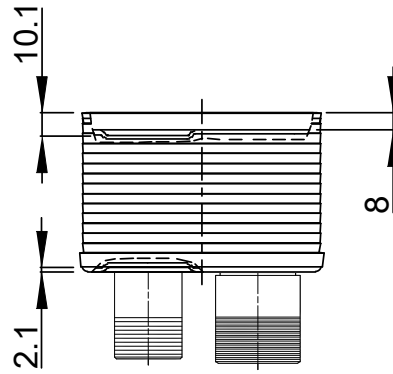
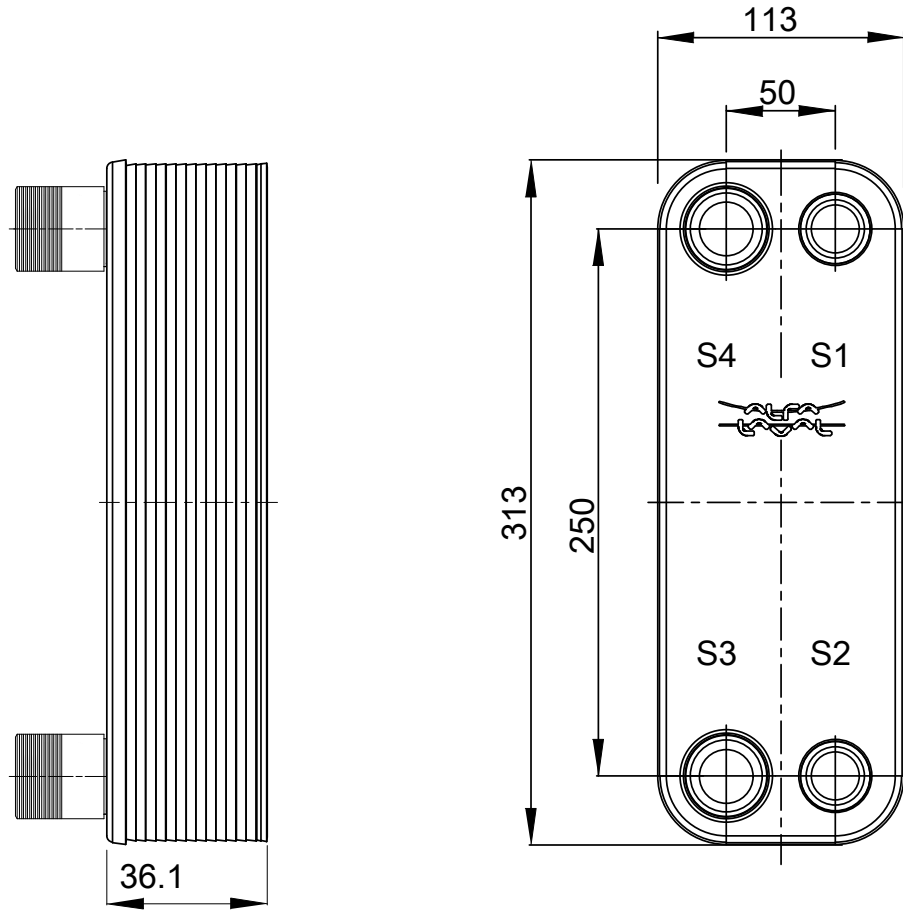
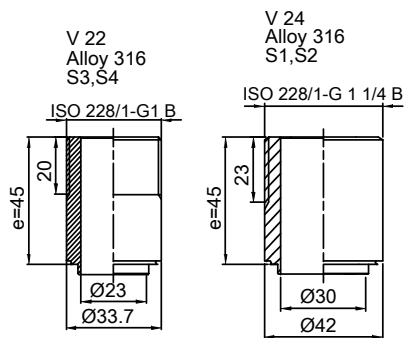

HEATING SURFACE
 NETWEIGHT 3.1 kg
 OPERATING WEIGHT kg
 PLATE MATERIAL ALLOY 316
 PLATE GROUPING 1*4L/1*5L

T1 T2 T3 T4 locations on back side correspond to S1 S2 S3 S4 on front side

ALL DIMENSIONS IN MILLIMETERS

SIDE	MEDIA	INLET	TEMP.	OUTLET	TEMP.	FLOW RATE	PRESSURE DROP	LIQUID VOL.
1		S1		S2				0.27 dm³
2		S3		S4				0.22 dm³

PRESSURE VESSEL APPROVAL

PED

CB30-10L (3287083377)

www.alfalaval.com

CUSTOMER NAME / REF. NO.

TOTAL LENGTH 81.1 mm
 TOTAL WIDTH 113.0 mm
 TOTAL HEIGHT 313.0 mm

COMPANY / REF.

1/15/2024
 REV 0