

Note that all unique customer requirements (i.e tolerance) need to be verified thru Alfa Laval.

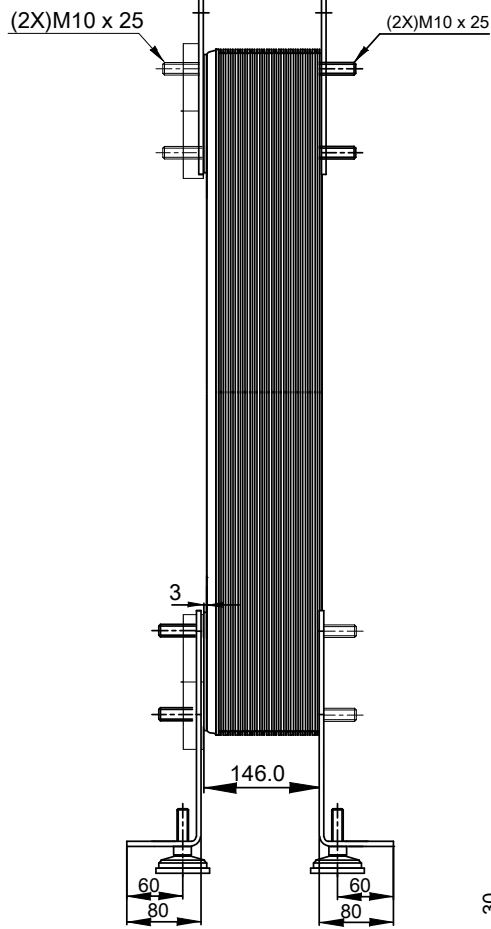

CPF80FP
Alloy 316
S1,S2,S3,S4

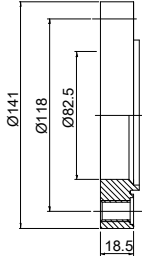

FRAME PLATE

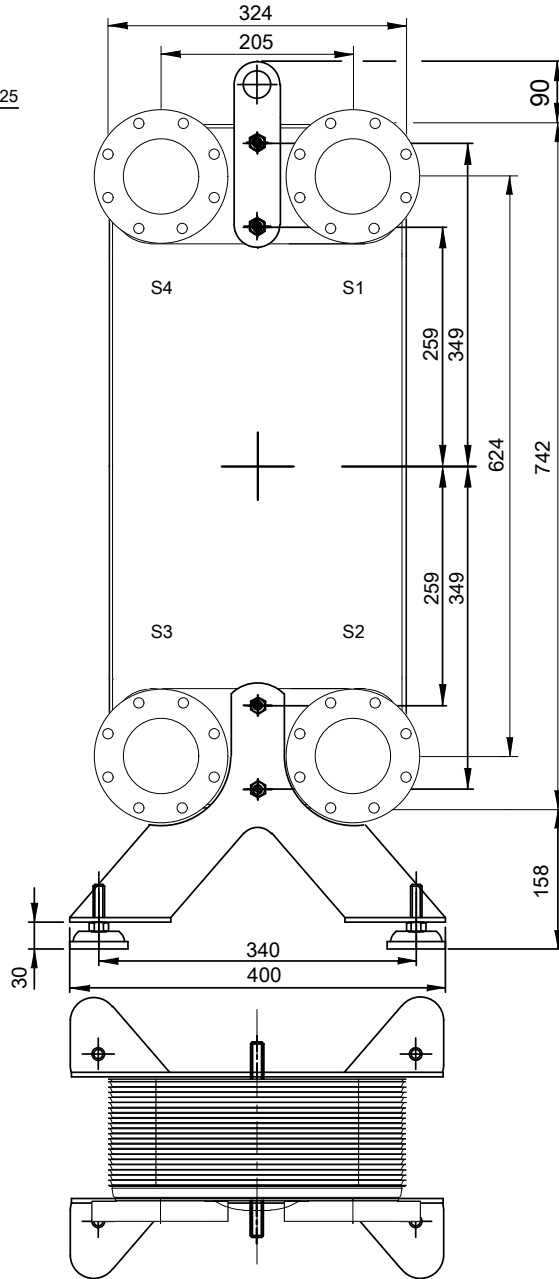

HEATING SURFACE
NETWEIGHT 47.9 kg
OPERATING WEIGHT kg
PLATE MATERIAL ALLOY 316
PLATE GROUPING 1*24ML/1*25MH

T1 T2 T3 T4 locations on back side correspond to S1 S2 S3 S4 on front side

ALL DIMENSIONS IN MILLIMETERS

SIDE	MEDIA	INLET	TEMP.	OUTLET	TEMP.	FLOW RATE	PRESSURE DROP	LIQUID VOL.
1		S1		S2				12.8 dm ³
2		S3		S4				12.2 dm ³

PRESSURE VESSEL APPROVAL

PED/UK



CB200-50M (3287070514)

www.alfalaval.com

CUSTOMER NAME / REF. NO.

TOTAL LENGTH 306.0 mm
TOTAL WIDTH 324.0 mm
TOTAL HEIGHT 990.0 mm

COMPANY / REF.



1/15/2024
REV 0