

Note that all unique customer requirements (i.e tolerance) need to be verified thru Alfa Laval.

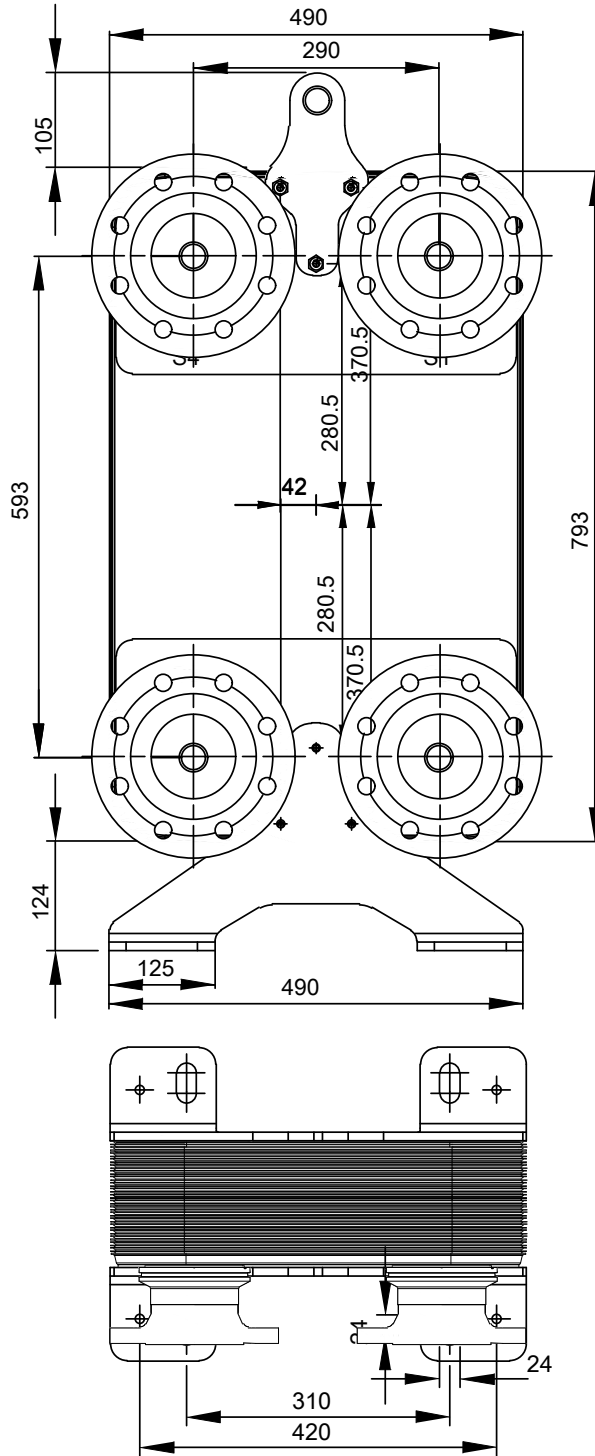
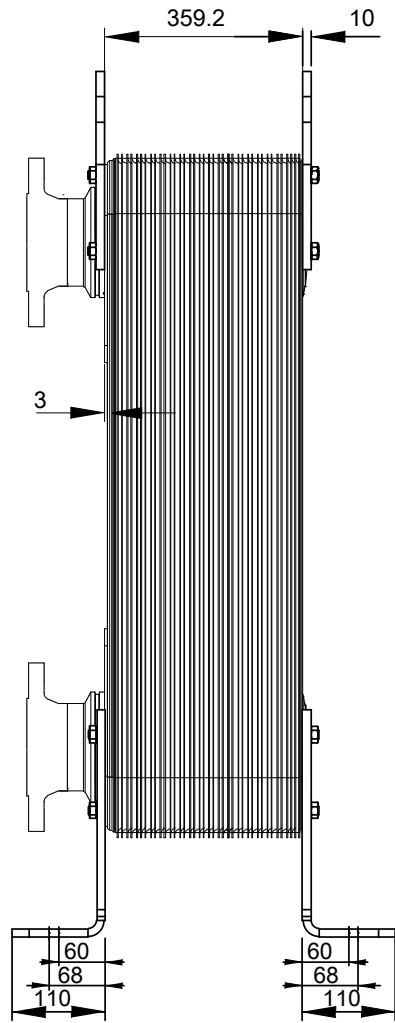
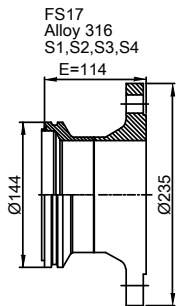

HEATING SURFACE
NETWEIGHT 242.6 kg
OPERATING WEIGHT kg
PLATE MATERIAL ALLOY 316
PLATE GROUPING 1*79L/1*80L

T1 T2 T3.1 T3.2 T4.1 T4.2 locations on back side
correspond to S1 S2 S3.1 S3.2 S4.1 S4.2 on front side

ALL DIMENSIONS IN MILLIMETERS

SIDE	MEDIA	INLET	TEMP.	OUTLET	TEMP.	FLOW RATE	PRESSURE DROP	LIQUID VOL.
1		S2		S1				55.2 dm ³
2		S4		S3				54.5 dm ³

PRESSURE VESSEL APPROVAL

PED



CBH410-160L-F (3075027472)

www.alfalaval.com

CUSTOMER NAME / REF. NO.

TOTAL LENGTH 583.2 mm
TOTAL WIDTH 490.0 mm
TOTAL HEIGHT 1022.0 mm

COMPANY / REF.



4/16/2024
REV 0