

This document and its contents are subject to copyrights and other intellectual property rights owned by Alfa Laval (pub) or any of its affiliates (Alfa Laval). No part of this document may be copied, reproduced or transmitted in any form or by any means, or for any purpose, without Alfa Laval's prior express written permission. Information and services provided in this document are made as a benefit and service to the user, and no representations or warranties are made about the accuracy or suitability of this information and these services for any purpose. All rights are reserved.

PRESSURE PLATE
(MOVABLE)

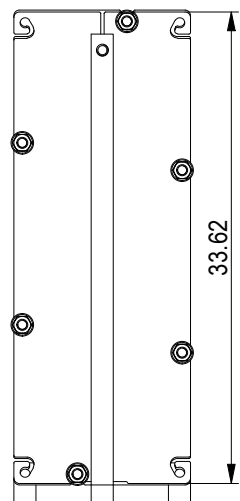

Space between pressure plate and supporting column should be kept free from fixed installations!

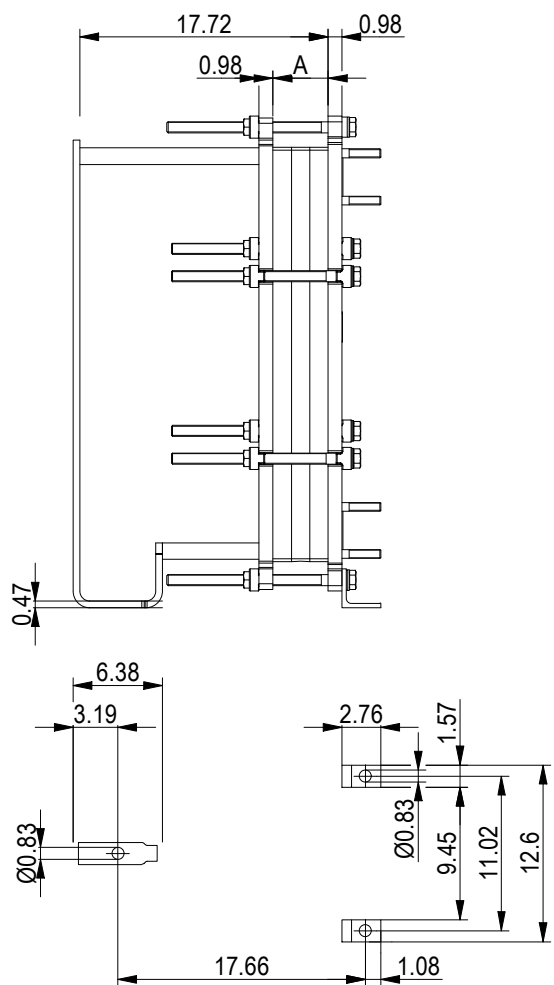

FRAME PLATE

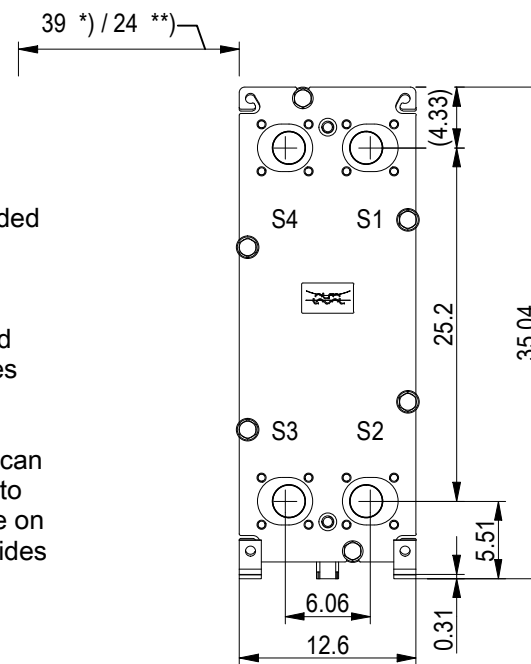

*) Recommended free space for opening and closing to be applied on both sides

**) Free space can be reduced to this distance on one of the sides

All dimensions in inches

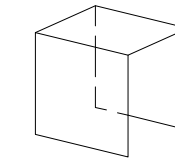
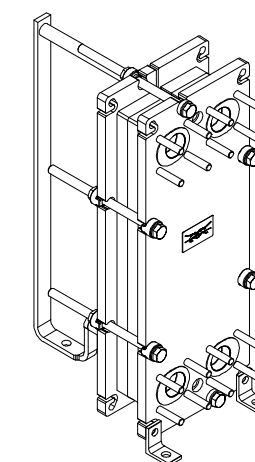

PROTECTION SHEET

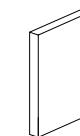

PRESSURE PLATE



FRAME PLATE

ASME B16.5 Class 150 NPS 2
S1, S2, S3, S4

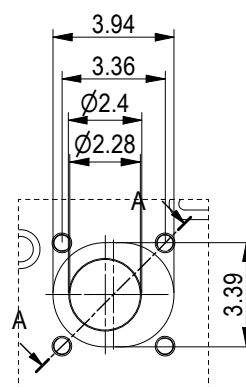

A-A:
ALLOY 316

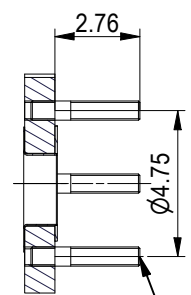

5/8"-11 UNC (x4)

TIGHTENING BOLTS 4 x M20, L = 18.9 in
2 x M20, L = 13.0 in

APPROX. OUTER DIMENSIONS
LENGTH 25.6 in
WIDTH 13.0 in
HEIGHT 34.6 in
APPROX. WEIGHTS
NET WEIGHT, EMPTY 406 lb
WEIGHT FULL OF WATER 437 lb
PLATE MATERIAL ALLOY 316
PLATE THICKNESS 0.5 mm
GASKET NBRP ClipGrip™
AREA OF HEAT SURFACE 85.6 ft²

NO. OF UNITS 1

10.0 GPM
9.9 GPM



www.alfalaval.com

DRAWING
GASKETED PLATE HEAT EXCHANGER

T6-BFG

ASME
Code Section VIII Div.1

MAWP 150 psi at 266.0 °F
MDMT -18.0 °F at 150 psi
Designed, constructed and stamped in accordance with 2021 ASME.

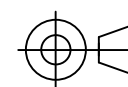

8240152979
T6-BFG, 55 plates

Do not use this drawing for foundation bolting or piping layout
or planning of lifting and handling of the equipment.

DATE 6/13/23
REVISION 0