

Note that all unique customer requirements (i.e tolerance) need to be verified thru Alfa Laval.

B 23  
Alloy 316  
S1, S2

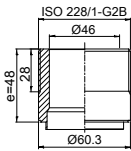

D 21  
Alloy 316  
S3, S4

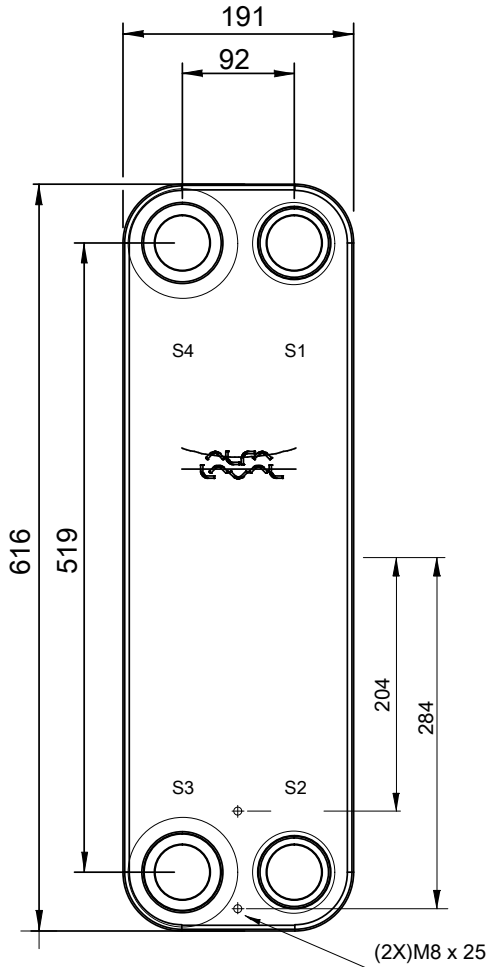
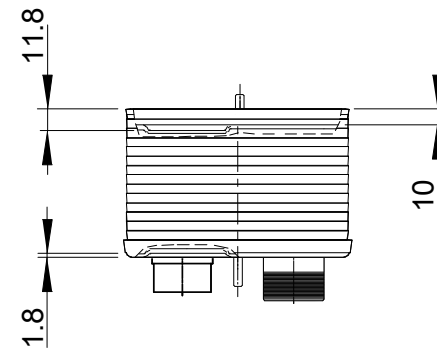
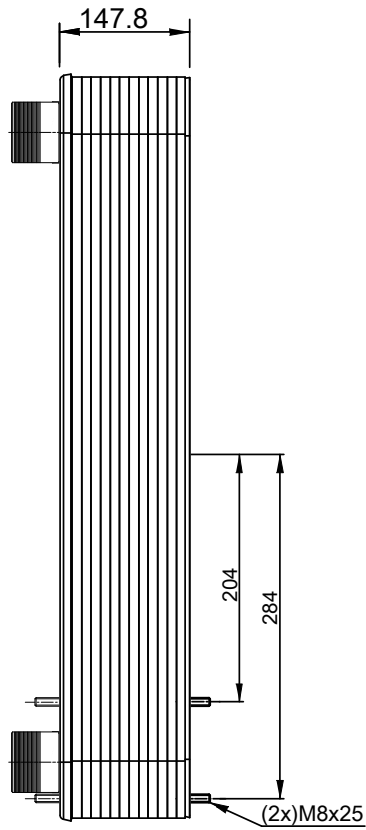
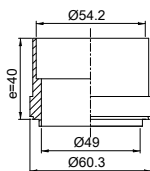

HEATING SURFACE  
NETWEIGHT 28.5 kg  
OPERATING WEIGHT kg  
PLATE MATERIAL ALLOY 316  
PLATE GROUPING 1\*31AHH/1\*32AHL

T1 T2 T3 T4 locations on back side correspond to S1 S2 S3 S4 on front side

ALL DIMENSIONS IN MILLIMETERS

SIDE	MEDIA	INLET	TEMP.	OUTLET	TEMP.	FLOW RATE	PRESSURE DROP	LIQUID VOL.
1		S1		S2				6.40 dm <sup>3</sup>
2		S3		S4				4.96 dm <sup>3</sup>

PRESSURE VESSEL APPROVAL

PED

CB112-64AH (3287118412)

www.alfalaval.com

CUSTOMER NAME / REF. NO.

TOTAL LENGTH 214.8 mm  
TOTAL WIDTH 191.0 mm  
TOTAL HEIGHT 616.0 mm

COMPANY / REF.



1/15/2024  
REV 0