

HEATING INSULATION INCLUDED

Thickness: 45 mm

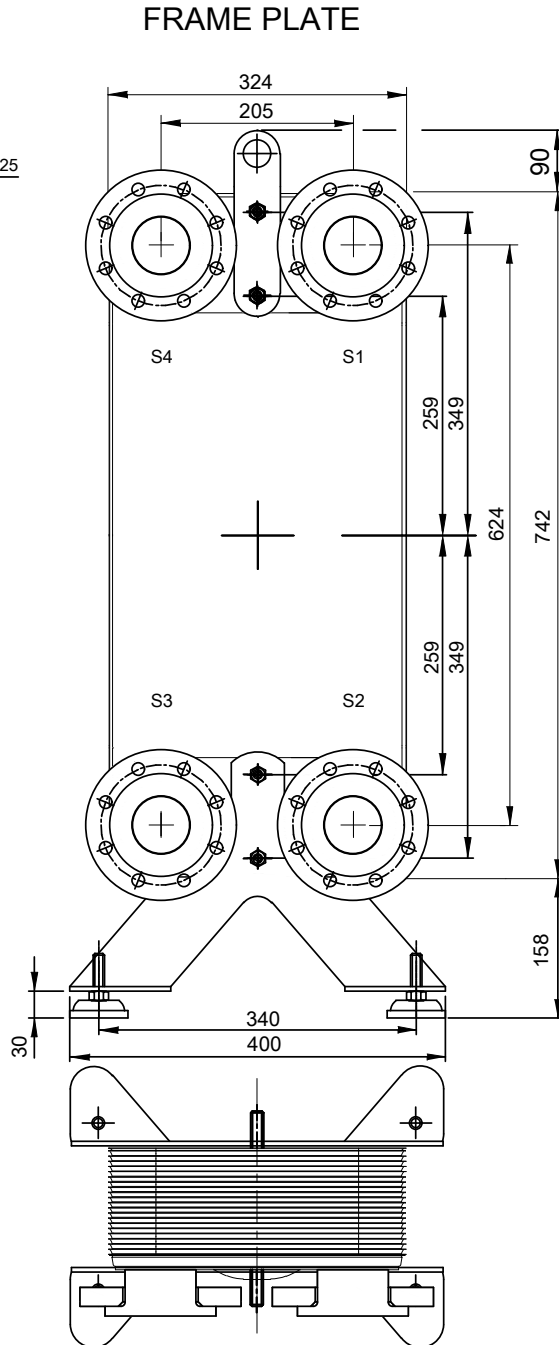

LFS DN80
Alloy 304
S1, S2, S3, S4

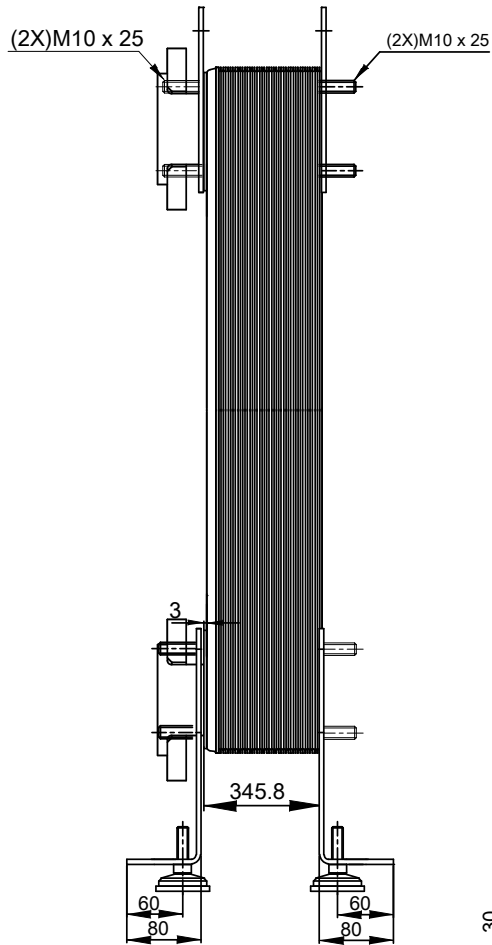
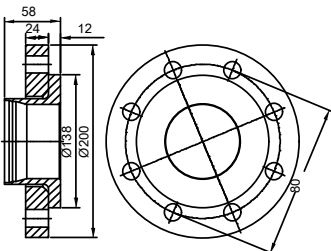

HEATING SURFACE
NETWEIGHT 111.0 kg
OPERATING WEIGHT kg
PLATE MATERIAL ALLOY 316
PLATE GROUPING 1*61H/1*62H

T1 T2 T3 T4 locations on back side
correspond to S1 S2 S3 S4 on front side

ALL DIMENSIONS IN MILLIMETERS

SIDE	MEDIA	INLET	TEMP.	OUTLET	TEMP.	FLOW RATE	PRESSURE DROP	LIQUID VOL.
1		S1		S2				31.6 dm ³
2		S3		S4				31.1 dm ³

Note that all unique customer requirements (i.e tolerance) need to be verified thru Alfa Laval.

PRESSURE VESSEL APPROVAL

PED/UK

CB200-124H+Mounted insulation (3287000766)

www.alfalaval.com

CUSTOMER NAME / REF. NO.

COMPANY / REF.

TOTAL LENGTH 505.8 mm
TOTAL WIDTH 324.0 mm
TOTAL HEIGHT 990.0 mm



1/15/2024
REV 0