

FRAME PLATE

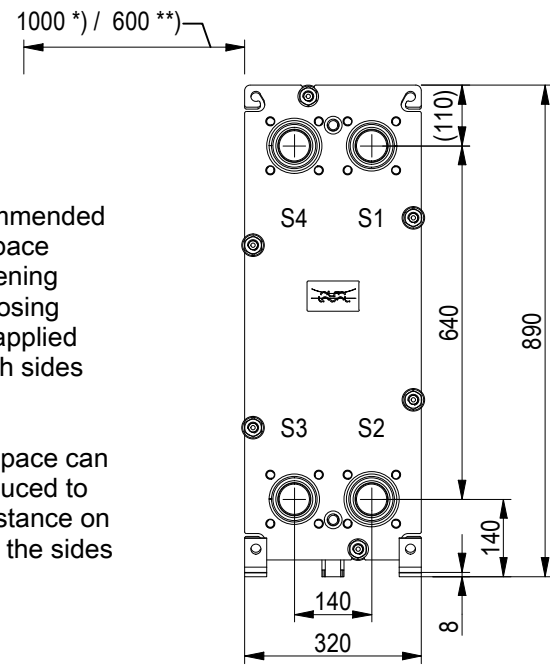

*) Recommended free space for opening and closing to be applied on both sides

**) Free space can be reduced to this distance on one of the sides

Space between pressure plate and supporting column should be kept free from fixed installations!

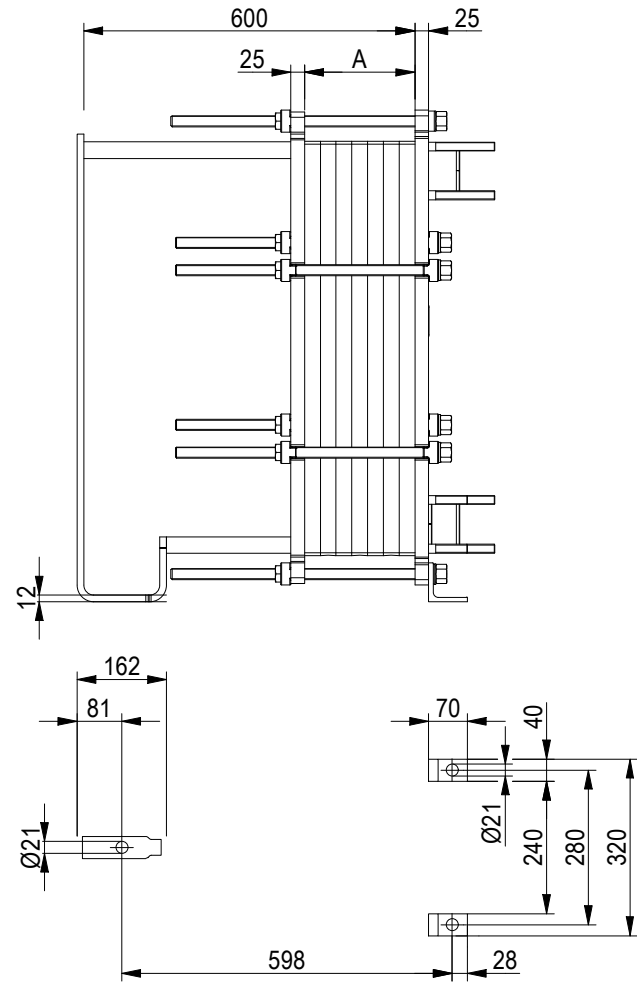

PRESSURE PLATE (MOVABLE)

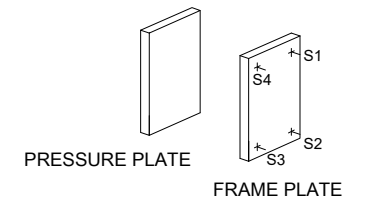
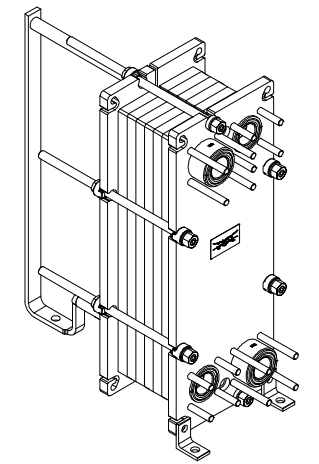
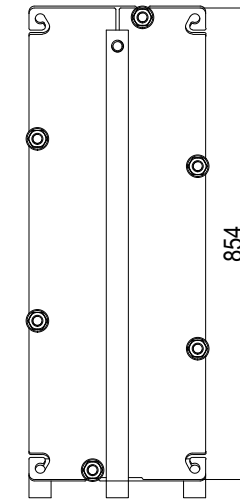

EN 1092-1 DN50 PN10
S1, S3

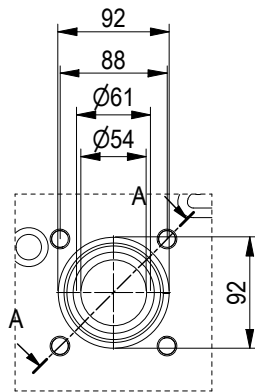

A-A:
NBRP / ALLOY 316

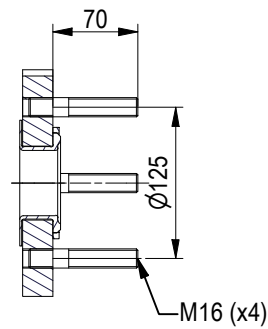

EN 1092-1 DN50 PN10
S2, S4

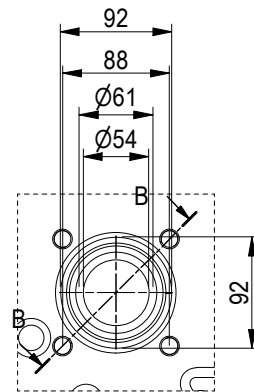

B-B:
NBRP / ALLOY 316

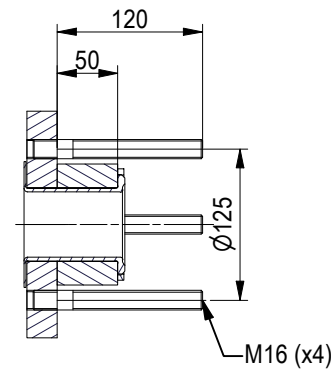

All dimensions in millimeters (mm)

NO. OF UNITS

1

APPROX. OUTER DIMENSIONS	
LENGTH	790 mm
WIDTH	330 mm
HEIGHT	880 mm
APPROX. WEIGHTS	
NET WEIGHT, EMPTY	168 kg
WEIGHT FULL OF WATER	193 kg
PLATE MATERIAL	ALLOY 316
PLATE THICKNESS	0.5 mm
GASKET	NBRP ClipGrip™

CHANNEL ARRANGEMENT 1*29 L / 1*30 L



www.alfalaval.com

DRAWING
GASKETED PLATE HEAT EXCHANGER

T6-PFM

PED Article 4.3

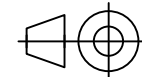

8240121006

Do not use this drawing for foundation bolting or piping layout

DATE 2/21/22
REVISION 0