

Note that all unique customer requirements (i.e tolerance) need to be verified thru Alfa Laval.

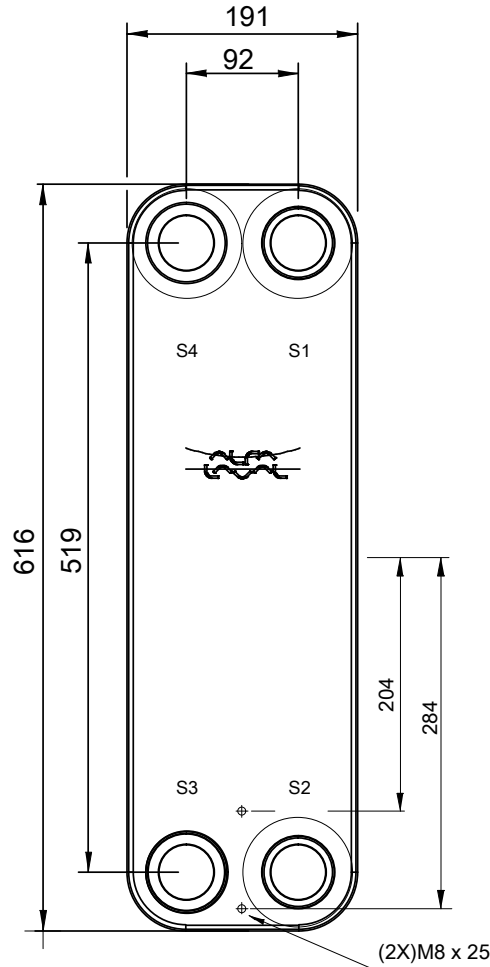
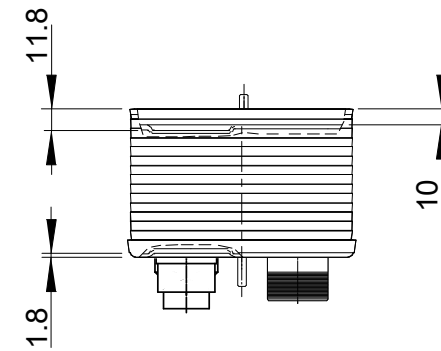
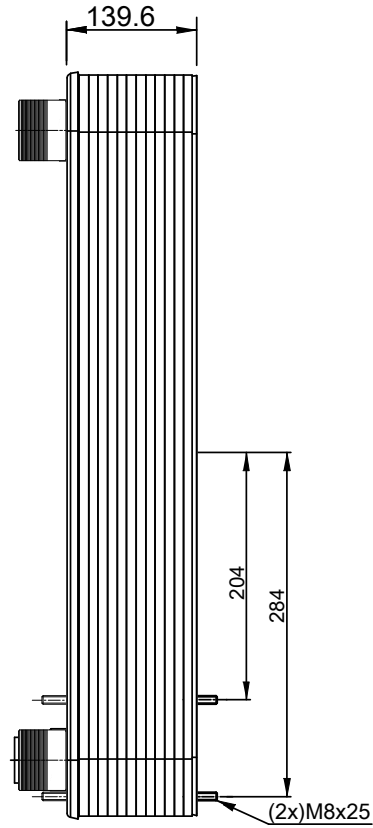
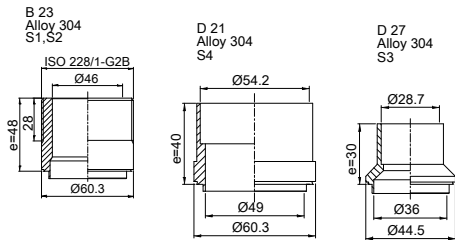

HEATING SURFACE  
 NETWEIGHT 27.0 kg  
 OPERATING WEIGHT kg  
 PLATE MATERIAL ALLOY 316  
 PLATE GROUPING 1\*29AMH/1\*30AML

T1 T2 T3 T4 locations on back side correspond to S1 S2 S3 S4 on front side

ALL DIMENSIONS IN MILLIMETERS

SIDE	MEDIA	INLET	TEMP.	OUTLET	TEMP.	FLOW RATE	PRESSURE DROP	LIQUID VOL.
1		S1		S2				6.00 dm <sup>3</sup>
2		S3		S4				4.64 dm <sup>3</sup>

PRESSURE VESSEL APPROVAL PED

AC220EQ-60AM-F (3287118774)

www.alfalaval.com

CUSTOMER NAME / REF. NO.

TOTAL LENGTH 206.6 mm  
 TOTAL WIDTH 191.0 mm  
 TOTAL HEIGHT 616.0 mm

COMPANY / REF.



1/15/2024  
 REV 0