

FRAME PLATE

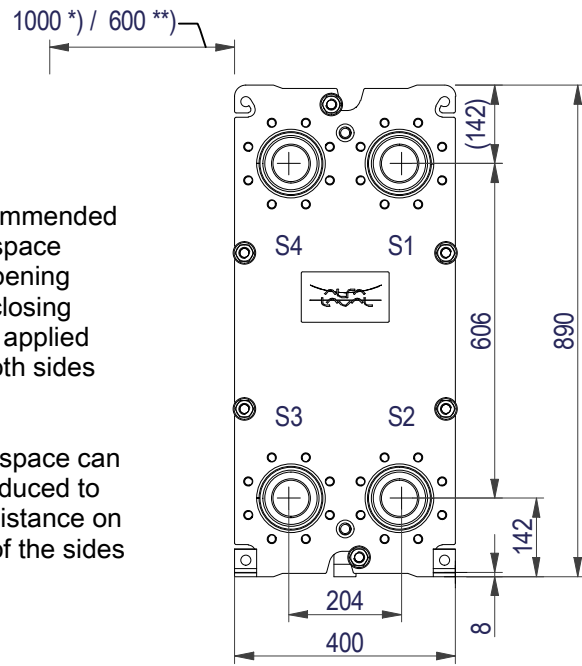

*) Recommended free space for opening and closing to be applied on both sides

**) Free space can be reduced to this distance on one of the sides

Space between pressure plate and supporting column should be kept free from fixed installations!

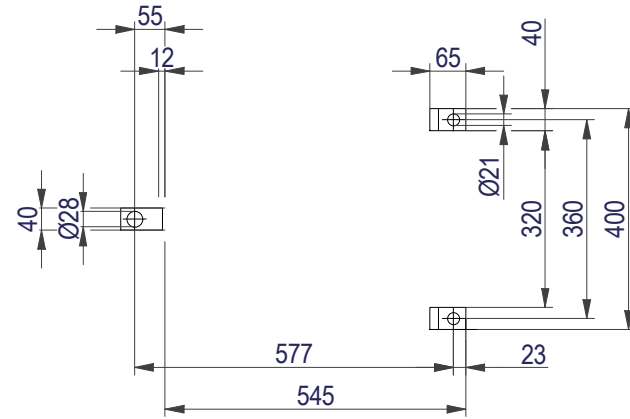
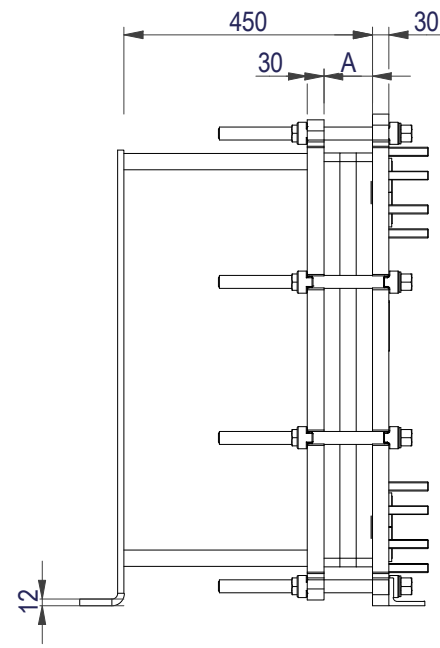

PRESSURE PLATE (MOVABLE)

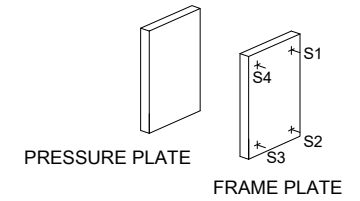
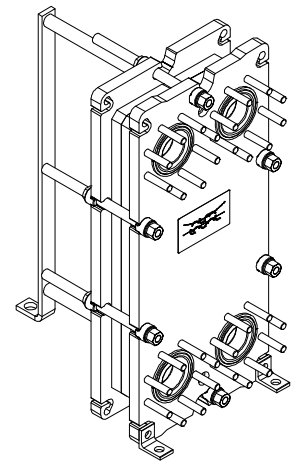
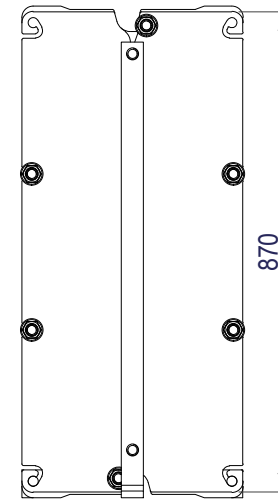

EN 1092-1 DN80 PN10
S1, S2, S3, S4

A-A:
NBRP / ALLOY 316

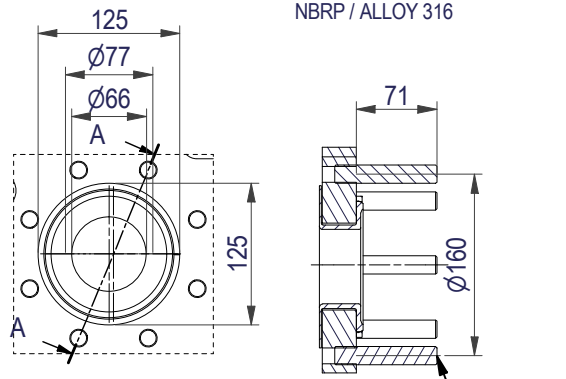

All dimensions in millimeters (mm)

NO. OF UNITS

1

APPROX. OUTER DIMENSIONS

LENGTH 570 mm
WIDTH 410 mm
HEIGHT 900 mm

APPROX. WEIGHTS

NET WEIGHT, EMPTY 218 kg
WEIGHT FULL OF WATER 240 kg
PLATE MATERIAL ALLOY 316
PLATE THICKNESS 0.5 mm
GASKET NBRP ClipGrip™

CHANNEL ARRANGEMENT 1*25 L
/ 1*24 L



www.alfalaval.com

DRAWING
GASKETED PLATE HEAT EXCHANGER

T8-BFM

PED Article 4.3

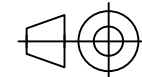

8240118477

Do not use this drawing for foundation bolting or piping layout

DATE 2/16/22
REVISION 0