

FRAME PLATE

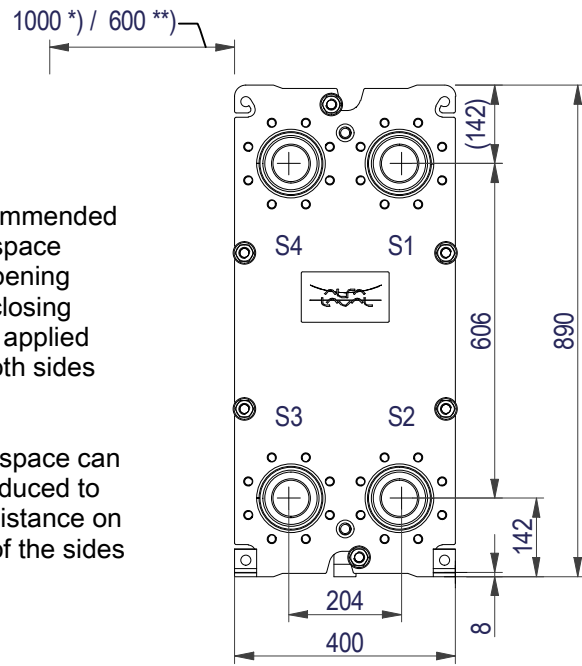

*) Recommended free space for opening and closing to be applied on both sides

**) Free space can be reduced to this distance on one of the sides

Space between pressure plate and supporting column should be kept free from fixed installations!

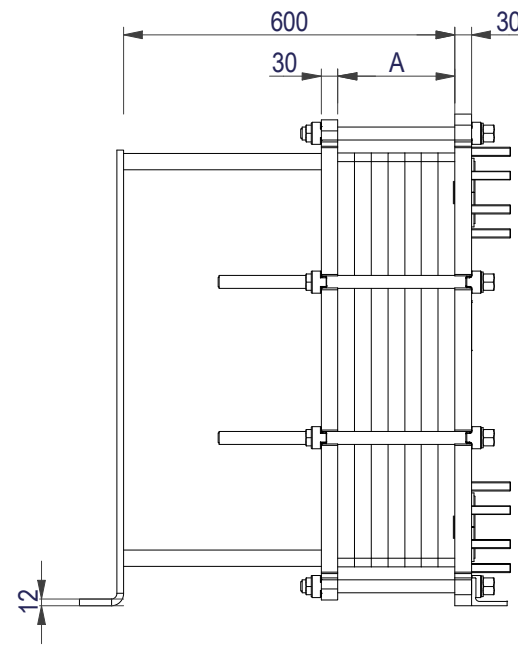

PRESSURE PLATE (MOVABLE)

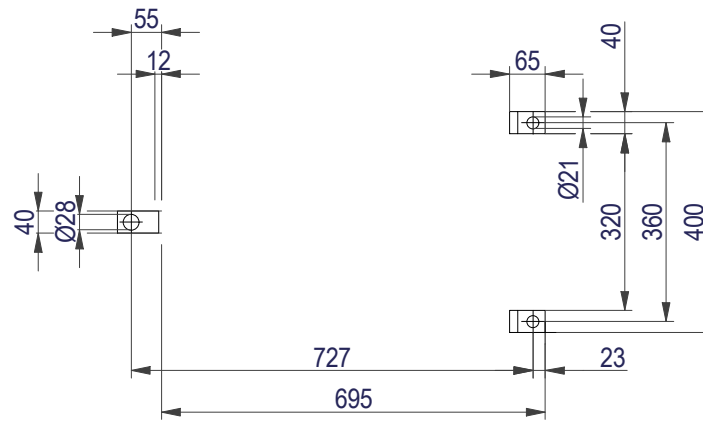
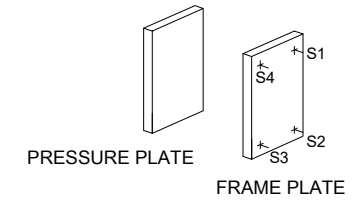
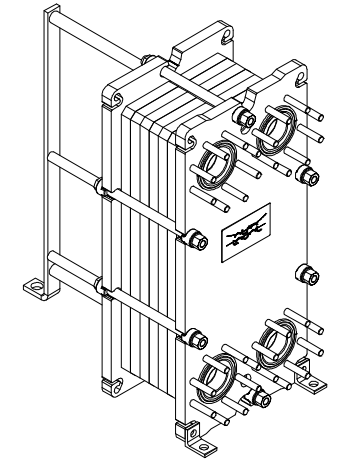
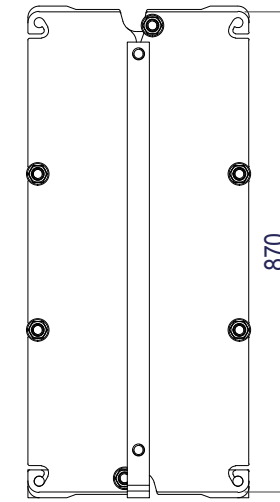

EN 1092-1 DN80 PN10
S1, S2, S3, S4

A-A:
NBRP / ALLOY 316

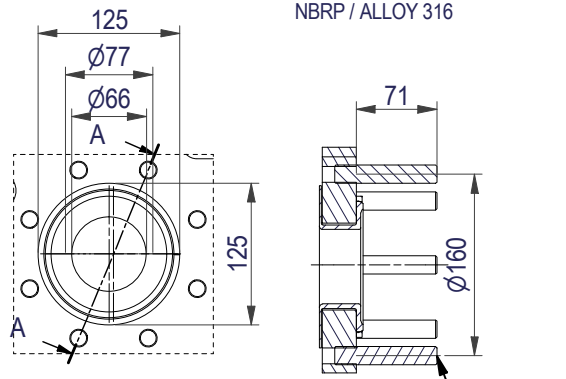

All dimensions in millimeters (mm)

NO. OF UNITS

1

APPROX. OUTER DIMENSIONS	
LENGTH	720 mm
WIDTH	410 mm
HEIGHT	900 mm
APPROX. WEIGHTS	
NET WEIGHT, EMPTY	235 kg
WEIGHT FULL OF WATER	263 kg
PLATE MATERIAL	ALLOY 316
PLATE THICKNESS	0.5 mm
GASKET	NBRP ClipGrip™

CHANNEL ARRANGEMENT 1*32 H
/ 1*32 H



www.alfalaval.com

DRAWING
GASKETED PLATE HEAT EXCHANGER

T8-BFM

PED Article 4.3

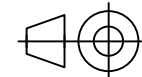

8240118371

Do not use this drawing for foundation bolting or piping layout

DATE 2/16/22
REVISION 0