

Note that all unique customer requirements (i.e tolerance) need to be verified thru Alfa Laval.

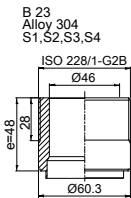
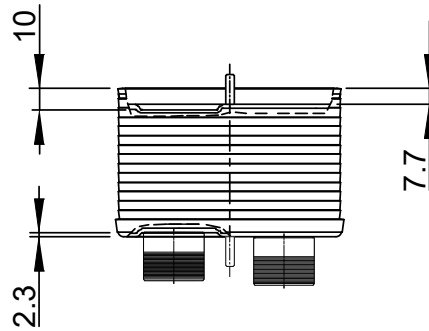
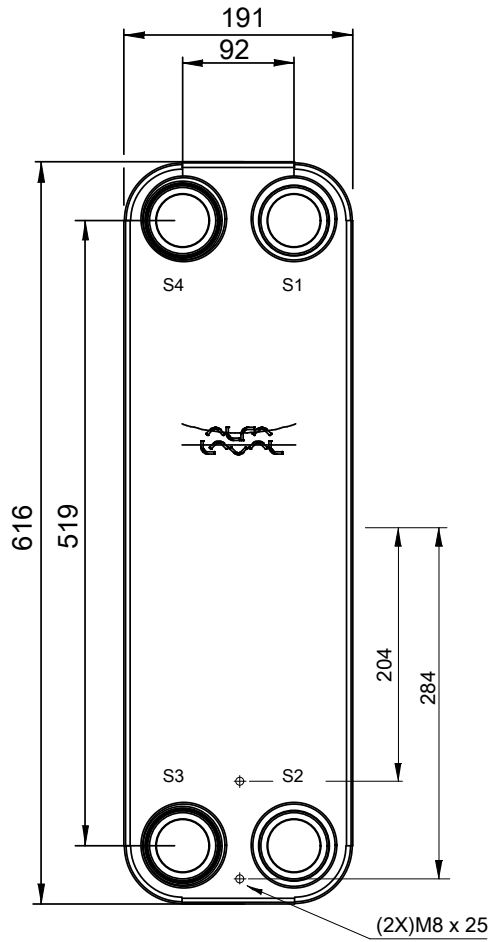
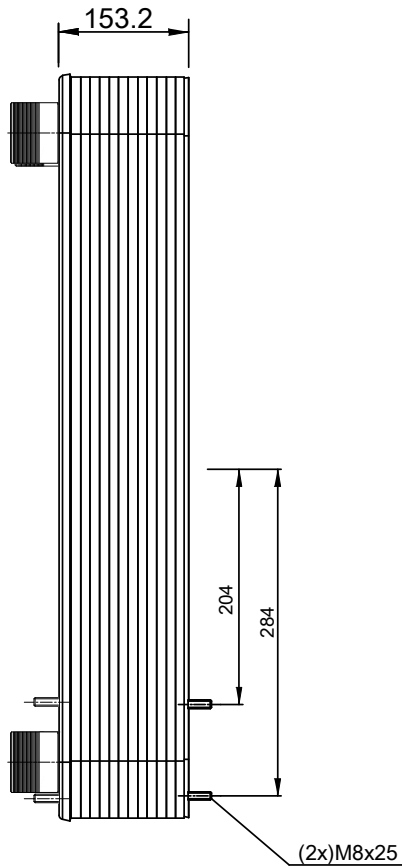

HEATING SURFACE
 NETWEIGHT 25.4 kg
 OPERATING WEIGHT kg
 PLATE MATERIAL ALLOY 316
 PLATE GROUPING 1*26ML/1*27MH

ALL DIMENSIONS IN MILLIMETERS

SIDE	MEDIA	INLET	TEMP.	OUTLET	TEMP.	FLOW RATE	PRESSURE DROP	LIQUID VOL.
1		S1		S2				5.67 dm ³
2		S3		S4				5.46 dm ³

PRESSURE VESSEL APPROVAL

PED



CB110-54M-F (3287109198)

www.alfalaval.com

CUSTOMER NAME / REF. NO.

TOTAL LENGTH 216.2 mm
 TOTAL WIDTH 191.0 mm
 TOTAL HEIGHT 616.0 mm

COMPANY / REF.



1/15/2024
 REV 0