

Note that all unique customer requirements (i.e tolerance) need to be verified thru Alfa Laval.

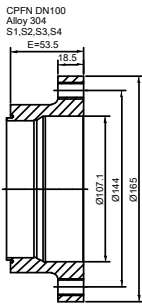
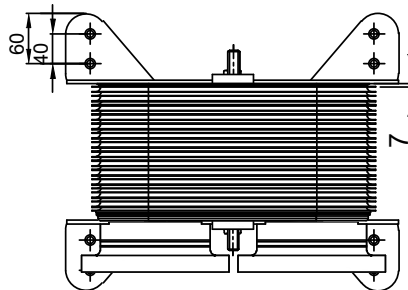
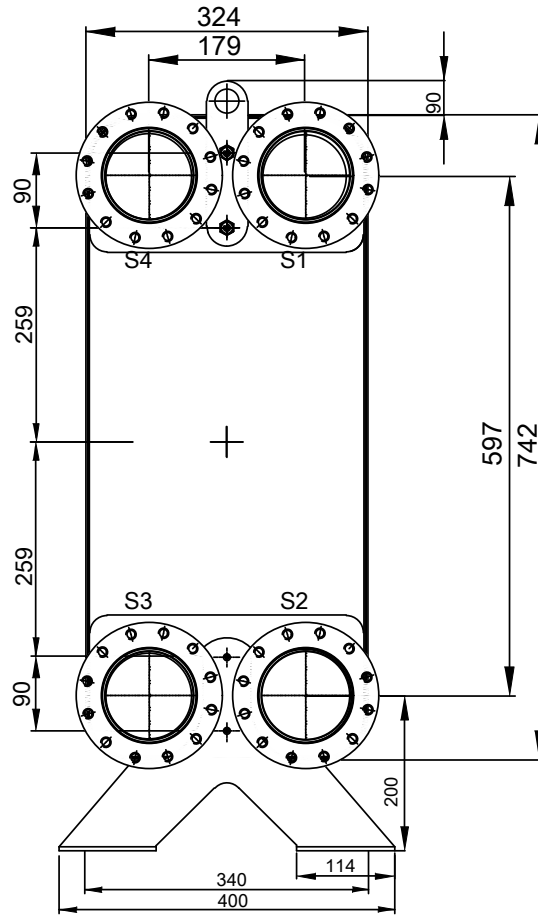
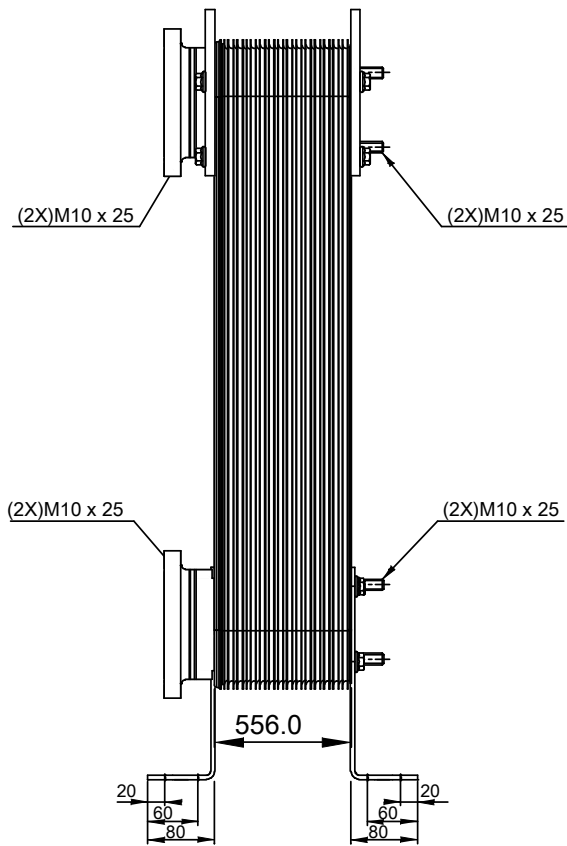

HEATING SURFACE
NETWEIGHT 174.1 kg
OPERATING WEIGHT kg
PLATE MATERIAL ALLOY 316
PLATE GROUPING 1*124ML/1*125MH

T1 T2 T3 T4 locations on back side correspond to S1 S2 S3 S4 on front side

ALL DIMENSIONS IN MILLIMETERS

SIDE	MEDIA	INLET	TEMP.	OUTLET	TEMP.	FLOW RATE	PRESSURE DROP	LIQUID VOL.
1		S1		S2				62.9 dm ³
2		S3		S4				62.4 dm ³

PRESSURE VESSEL APPROVAL

PED/UK

CB210-250M-F (3075023523)

www.alfalaval.com

CUSTOMER NAME / REF. NO.

TOTAL LENGTH 716.0 mm
TOTAL WIDTH 324.0 mm
TOTAL HEIGHT 959.0 mm

COMPANY / REF.



4/16/2024
REV 0