

Note that all unique customer requirements (i.e tolerance) need to be verified thru Alfa Laval.

OC01  
Alloy 304  
S1,S2,S3,S4

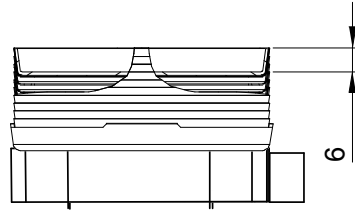
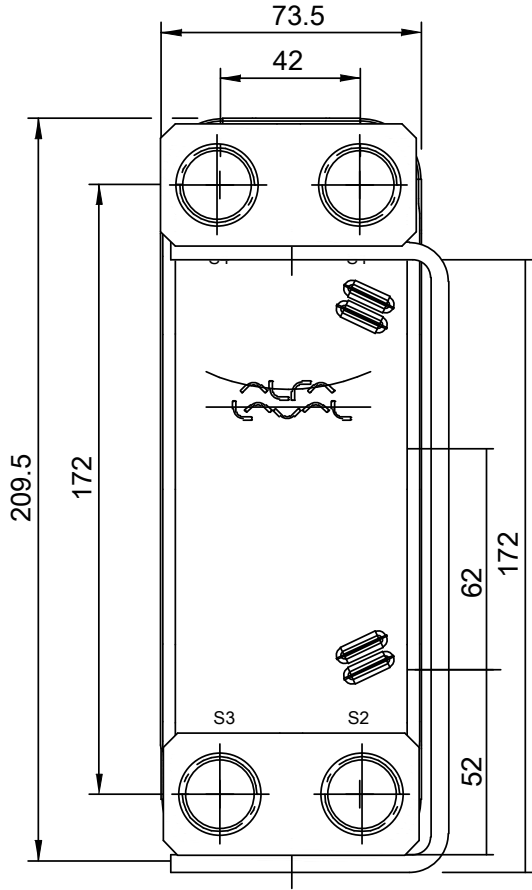
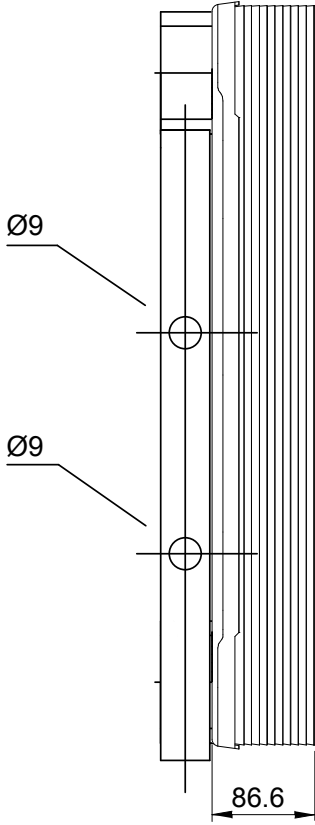
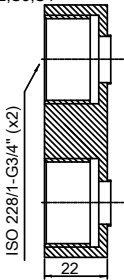

HEATING SURFACE  
NETWEIGHT 2.2 kg  
OPERATING WEIGHT kg  
PLATE MATERIAL ALLOY 316  
PLATE GROUPING 1\*17AH/1\*18AL

T1 T2 T3 T4 locations on back side correspond to S1 S2 S3 S4 on front side

ALL DIMENSIONS IN MILLIMETERS

SIDE	MEDIA	INLET	TEMP.	OUTLET	TEMP.	FLOW RATE	PRESSURE DROP	LIQUID VOL.
1		S1		S2				0.54 dm³
2		S3		S4				0.41 dm³



PRESSURE VESSEL APPROVAL PED/UK  
DOC16-36A-F (3287119982)

www.alfalaval.com

CUSTOMER NAME / REF. NO.

COMPANY / REF.

TOTAL LENGTH 108.6 mm  
TOTAL WIDTH 73.5 mm  
TOTAL HEIGHT 209.5 mm

1/15/2024  
REV 0