

### FRAME PLATE

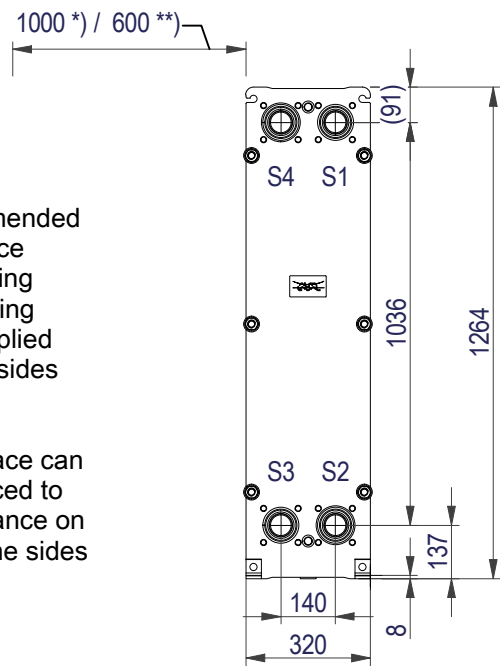

\*) Recommended free space for opening and closing to be applied on both sides

\*\*) Free space can be reduced to this distance on one of the sides

Space between pressure plate and supporting column should be kept free from fixed installations!

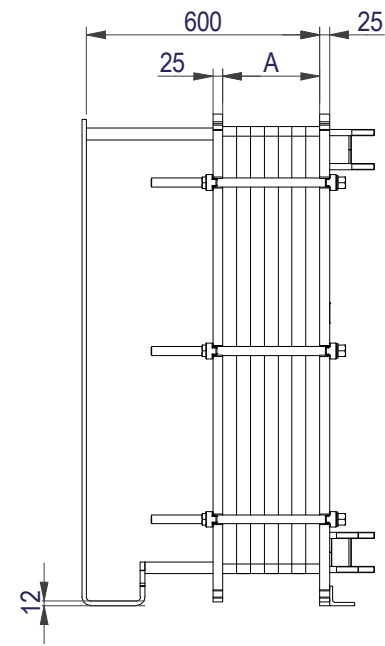

### PRESSURE PLATE (MOVABLE)

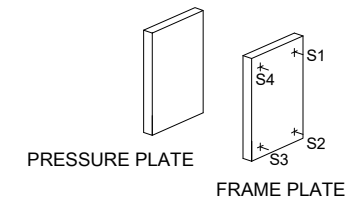
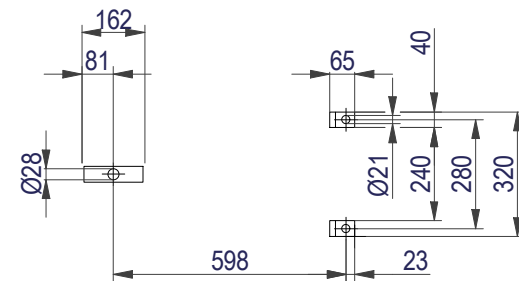
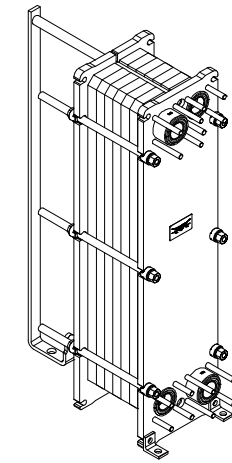
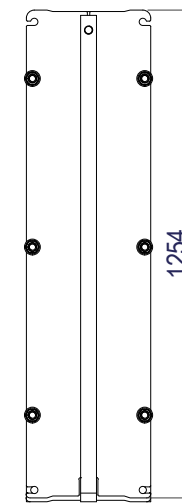

EN 1092-1 DN50 PN16  
S1, S3

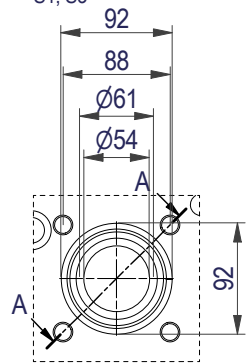

A-A:  
NBRP / ALLOY 254

EN 1092-1 DN50 PN16  
S2, S4

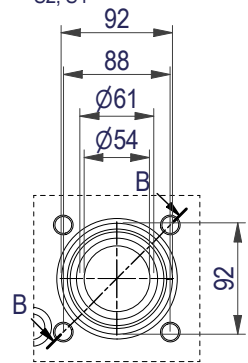

B-B:  
NBRP / ALLOY 254

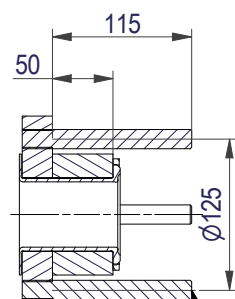

All dimensions in millimeters (mm)

NO. OF UNITS

1

#### APPROX. OUTER DIMENSIONS

LENGTH	780 mm
WIDTH	330 mm
HEIGHT	1270 mm

#### APPROX. WEIGHTS

NET WEIGHT, EMPTY	295 kg
WEIGHT FULL OF WATER	337 kg
PLATE MATERIAL	ALLOY 316
PLATE THICKNESS	0.5 mm
GASKET	NBRP Clip-on

CHANNEL ARRANGEMENT 1\*49 H / 1\*50 H



www.alfalaval.com

DRAWING  
GASKETED PLATE HEAT EXCHANGER

# TL6-BFM

PED Article 4.3

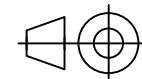

8240123135

Do not use this drawing for foundation bolting or piping layout

DATE	2/24/22
REVISION	0