

FRAME PLATE

*) Recommended free space for opening and closing to be applied on both sides

**) Free space can be reduced to this distance on one of the sides

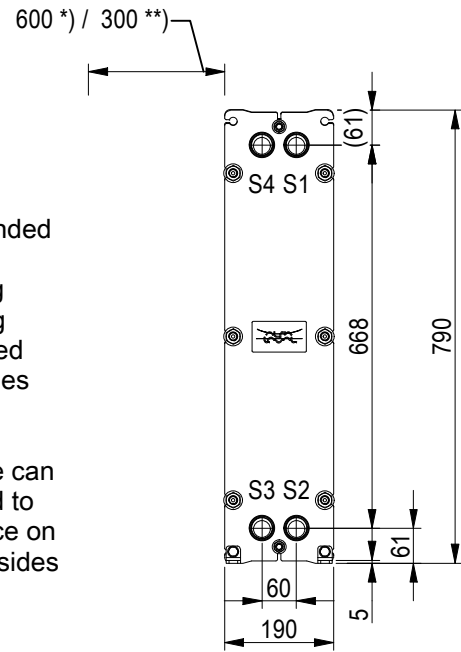

Space between pressure plate and supporting column should be kept free from fixed installations!

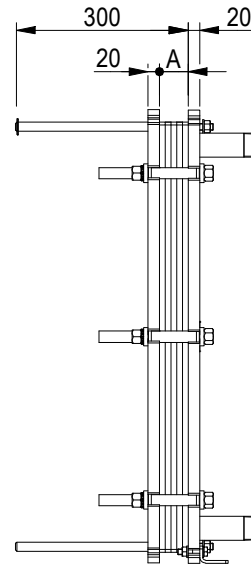

PRESSURE PLATE (MOVABLE)

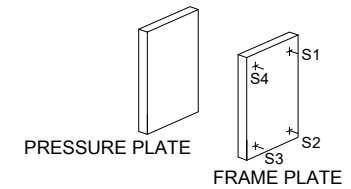
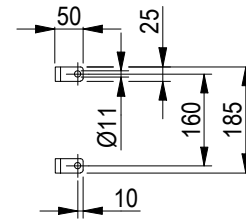
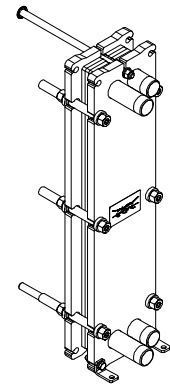
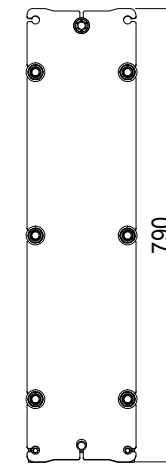

ISO 7 - R 1 1/4, ALLOY 316, 80 mm
S1, S2

A-A:

ISO 7 - R 1 1/4, ALLOY 316, 120 mm
S3, S4

C-C:

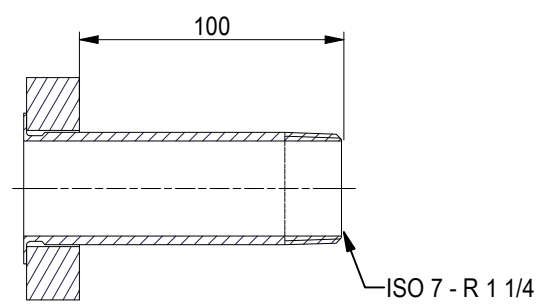
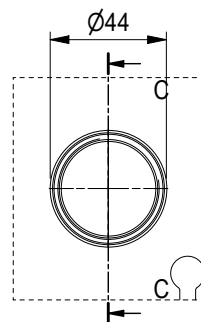
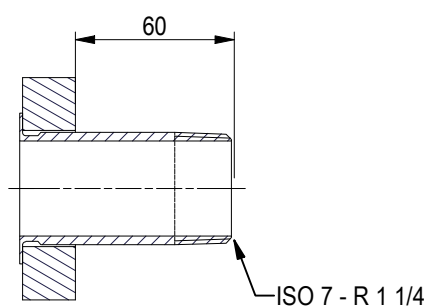
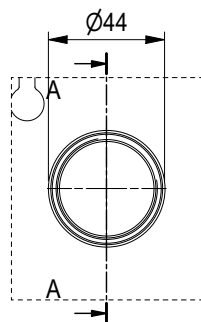

All dimensions in millimeters (mm)

NO. OF UNITS

1

APPROX. OUTER DIMENSIONS	
LENGTH	310 mm
WIDTH	200 mm
HEIGHT	800 mm
APPROX. WEIGHTS	
NET WEIGHT, EMPTY	47.5 kg
WEIGHT FULL OF WATER	50.1 kg
PLATE MATERIAL	ALLOY 316
PLATE THICKNESS	0.5 mm
GASKET	NBRP Clip-on

CHANNEL ARRANGEMENT 1*9 H / 1*10 H



www.alfalaval.com

DRAWING
GASKETED PLATE HEAT EXCHANGER

TL3-BFG

PED Article 4.3

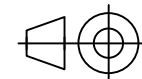

8240123435

Do not use this drawing for foundation bolting or piping layout

DATE 2/25/22
REVISION 0