



Alfa Laval AC502DQ / ACH502DQ / ACK502DQ

Brazed plate heat exchanger for air conditioning and refrigeration

Introduction

Alfa Laval AC brazed plate heat exchangers provide efficient heat transfer with a small footprint. They are specifically designed to work in air conditioning and refrigeration applications as evaporators and condensers in chillers and heat pumps.

Applications

- Evaporator
- Condenser

Benefits

- Compact
- Easy to install
- Self-cleaning
- Low level of service and maintenance is required
- All units are pressure and leak tested
- Gasket free

Branded Features



DynaStatic™ Flexible refrigerant distribution



FlexFlow™ Superior thermal performance



PressureSecure Unparalleled strength for demanding duties



REFuture A future-proof investment for tomorrow's refrigerants



ValuePlus Total support – with value-adding options to fit your needs

Design

The brazing material seals and holds the plates together at the contact points ensuring optimal heat transfer efficiency and pressure resistance. Using advanced design technologies and extensive verification guarantees the highest performance and longest possible service life.

Different pressure ratings are available for different needs.

The True dual-circuit design provides a higher freezing resistance compared to back-to-back solutions.



Asymmetric channels provide optimal efficiency in the most compact design. This results in low refrigerant charge or lower pressure drop on the water or brine side, reducing the CO₂ footprint.

The asymmetry guarantees the best performance in both full- and partial-load conditions.

Designed for high-efficiency applications, such as those applications with high evaporation temperature and low water/brine pressure drop. This results in reduced environmental impact and lower costs.

The integrated distribution system ensures an even distribution of the refrigerant throughout the plate package.

Based on standard components and a modular concept, each unit is custom-built to meet the specific requirements of each individual installation.

Suitable with most HFC, HFO and natural refrigerants.

Examples of connections

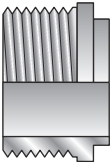

External thread

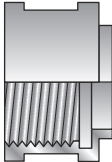

Internal thread



Soldering

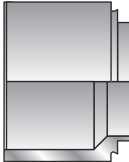

Welding



Grooved connection

Technical Data

Standard materials

| | |
|----------------|-----------------|
| Cover plates | Stainless steel |
| Connections | Stainless steel |
| Plates | Stainless steel |
| Brazing filler | Copper |

Dimensions and weight ¹

| | |
|--------------------------|--------------------|
| A measure (mm) | 12 + (2.52 * n) |
| A measure (inches) | 0.47 + (0.10 * n) |
| Weight (kg) ² | 13 + (0.48 * n) |
| Weight (lb) ² | 28.66 + (1.06 * n) |

¹ n = number of plates

² Excluding connections

Standard data

| | |
|--|---------------------------|
| Volume per channel, litres (gal) | H (S1-S2): 0.52 (0.1374) |
| | H (S3-S4): 0.5 (0.1321) |
| | AH (S1-S2): 0.52 (0.1374) |
| | AH (S3-S4): 0.45 (0.1189) |
| Max. particle size, mm (inch) | 1.1 (0.043) |
| Max. flowrate ¹ m ³ /h (gpm) | 120 (528.3) |
| Flow direction | Parallel |
| Min. number of plates | 10 |
| Max. number of plates | 270 |

¹ Water at 5 m/s (16.4 ft/s) (connection velocity)

Dimensional drawing

Measurements in mm (inches)

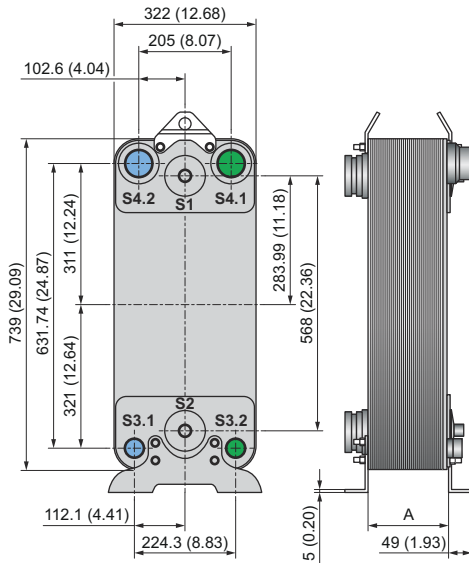

Design pressure and temperature

AC502DQ/ACH502DQ – PED approval pressure/temperature graph

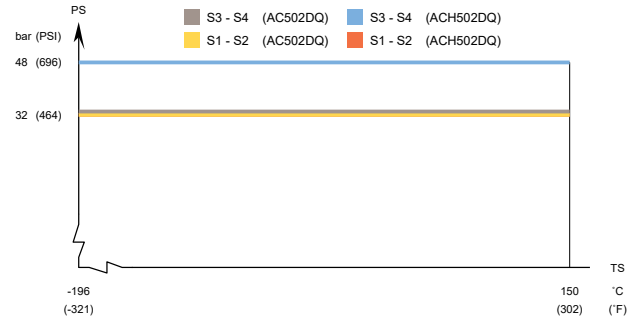

AC502DQ/ACH502DQ – UL approval pressure/temperature graph

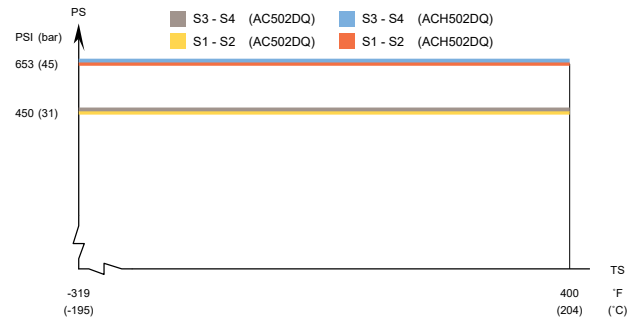

ACK502DQ – PED approval pressure/temperature graph

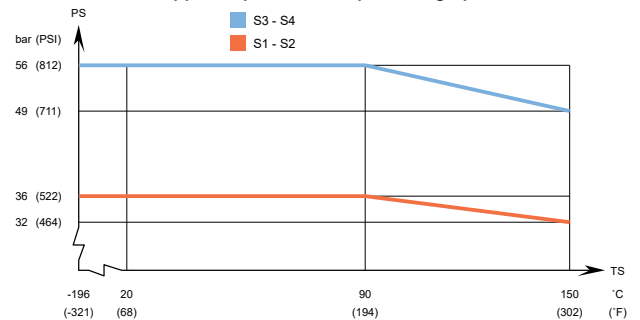

Designed for full vacuum.

Alfa Laval plate heat exchangers are available with a wide range of pressure vessel approvals. Please contact your Alfa Laval representative for more information.

NOTE: Values above are to be used as an indication. For exact values, please use the drawing generated by the Alfa Laval configurator or contact your local Alfa Laval representative.

This document and its contents are subject to copyrights and other intellectual property rights owned by Alfa Laval Corporate AB. No part of this document may be copied, re-produced or transmitted in any form or by any means, or for any purpose, without Alfa Laval Corporate AB's prior express written permission. Information and services provided in this document are made as a benefit and service to the user, and no representations or warranties are made about the accuracy or suitability of this information and these services for any purpose. All rights are reserved.

How to contact Alfa Laval

Up-to-date Alfa Laval contact details for all countries are always available on our website at www.alfalaval.com