

Note that all unique customer requirements (i.e tolerance) need to be verified thru Alfa Laval.

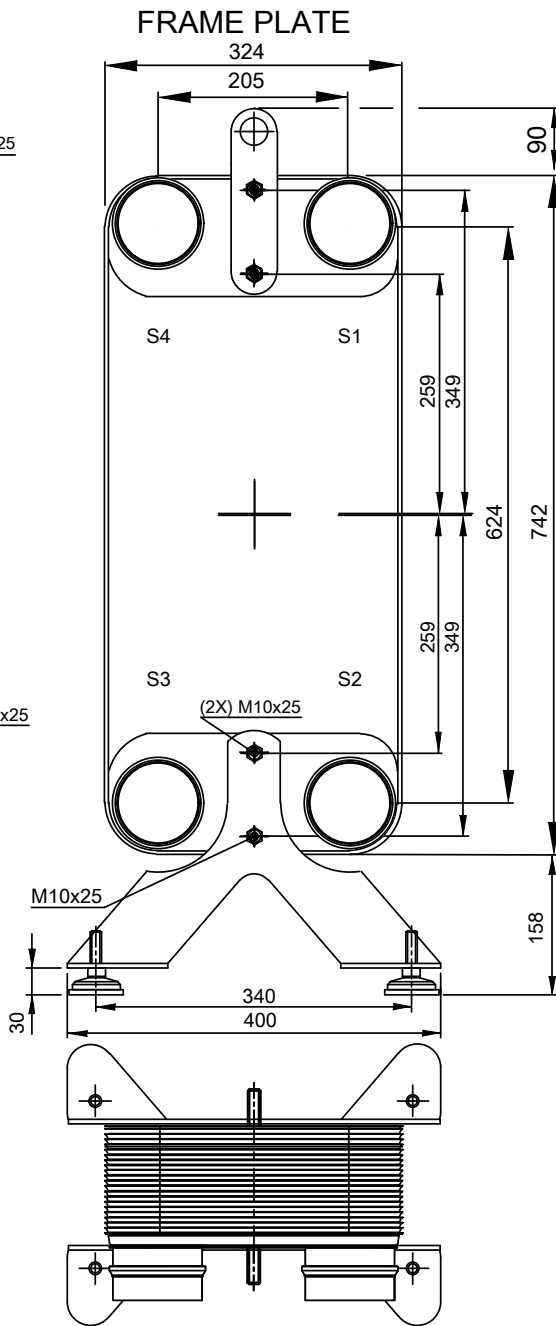
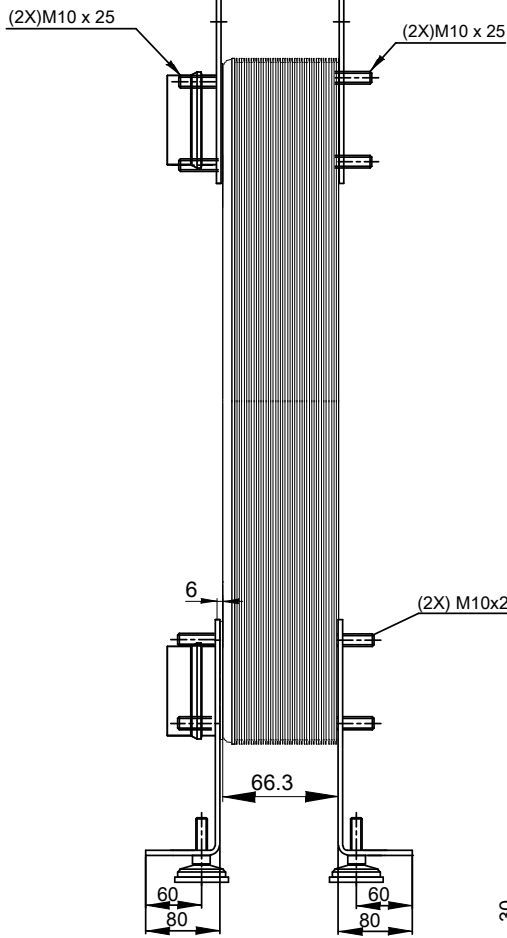
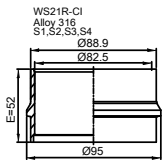

HEATING SURFACE
 NETWEIGHT 30.2 kg
 OPERATING WEIGHT kg
 PLATE MATERIAL ALLOY 316
 PLATE GROUPING 1*9H/1*10H

T1 T2 T3 T4 locations on back side correspond to S1 S2 S3 S4 on front side

ALL DIMENSIONS IN MILLIMETERS

SIDE	MEDIA	INLET	TEMP.	OUTLET	TEMP.	FLOW RATE	PRESSURE DROP	LIQUID VOL.
1		S1		S2				5.10 dm ³
2		S3		S4				4.59 dm ³

PRESSURE VESSEL APPROVAL

PED/UK



AlfaNova HP 200-20H (3287168745)

www.alfalaval.com

CUSTOMER NAME / REF. NO.

TOTAL LENGTH 226.3 mm
 TOTAL WIDTH 324.0 mm
 TOTAL HEIGHT 990.0 mm

COMPANY / REF.



4/16/2024
 REV 0