

### FRAME PLATE

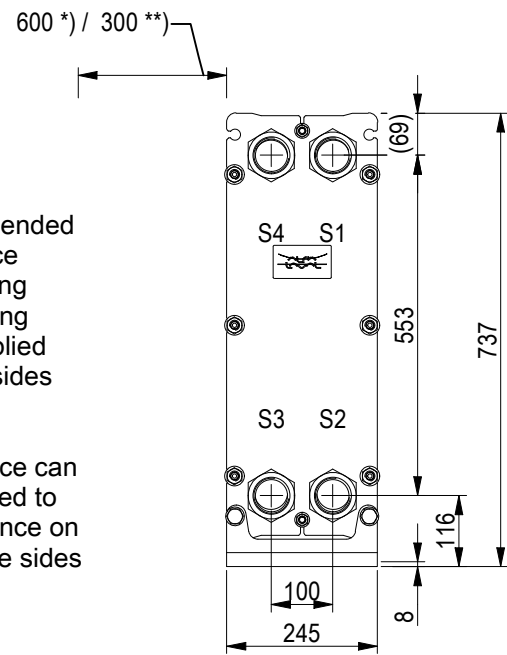

\*) Recommended free space for opening and closing to be applied on both sides

\*\*) Free space can be reduced to this distance on one of the sides

Space between pressure plate and supporting column should be kept free from fixed installations!

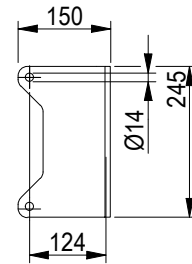
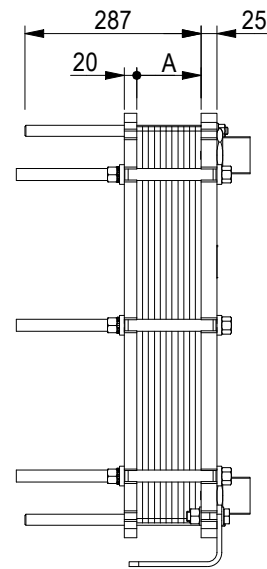

### PRESSURE PLATE (MOVABLE)

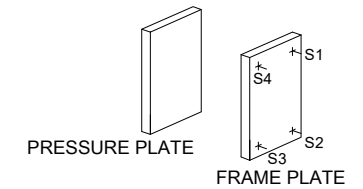
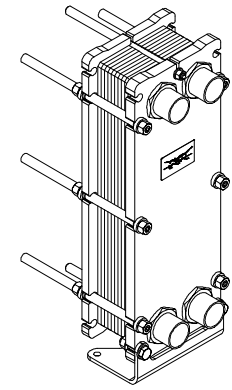
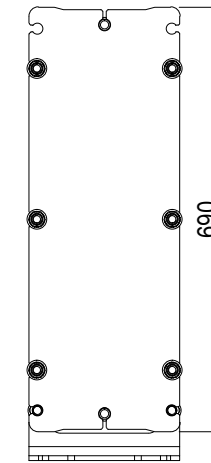

ISO 228 - G 2 B, ALLOY 316, 80 mm  
S1, S2, S3, S4

A-A:

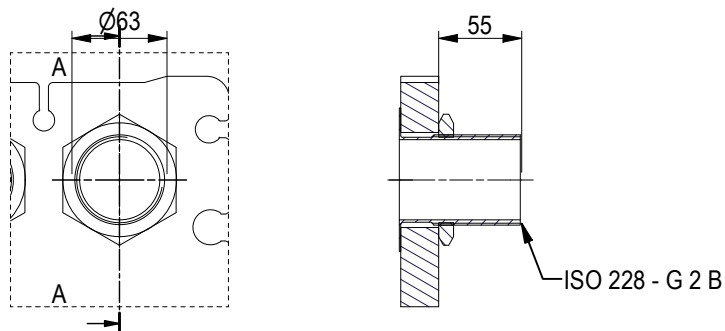

All dimensions in millimeters (mm)

NO. OF UNITS

1

APPROX. OUTER DIMENSIONS	
LENGTH	300 mm
WIDTH	260 mm
HEIGHT	700 mm
APPROX. WEIGHTS	
NET WEIGHT, EMPTY	86.8 kg
WEIGHT FULL OF WATER	94.0 kg
PLATE MATERIAL	ALLOY 316
PLATE THICKNESS	0.5 mm
GASKET	NBRP Clip-on

CHANNEL ARRANGEMENT 1\*24 ML / 1\*25 MH



www.alfalaval.com

DRAWING  
GASKETED PLATE HEAT EXCHANGER

# T5-BFG

PED Article 4.3

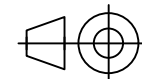

8240124153

Do not use this drawing for foundation bolting or piping layout

DATE 2/28/22  
REVISION 0