

Alfa Laval SMP-BCA

Double seal valves

Introduction

The Alfa Laval SMP-BCA Mixproof Valve with PTFE Diaphragm is an aseptic double-seal valve designed for use under aseptic conditions and sterilization involving high temperatures. Based on the Alfa Laval SMP-BC, the SMP-BCA features a straightforward design that keeps liquids separated using two seals on the same plug with a leakage chamber in between. With its PTFE face and reinforced EPDM rubber backing, the diaphragm follows the plug movement of the upper valve body and ensures no increase in the concentration of microorganisms in the product during processing.

Application

This aseptic double-seal mixproof valve is designed for extended shelf-life and aseptic applications in the dairy, food, beverage, biotech, pharmaceutical and many other industries.

Benefits

- Aseptic double-seal mixproof valve
- Versatile, modular design meets most aseptic application requirements
- Cost effective
- Easy to maintain

Working principle

The Alfa Laval SMP-BCA Mixproof Valve is operated by means of compressed air from a remote location. This aseptic valve is a normally closed (NC) valve. A specially designed diaphragm unit with a PTFE face and reinforced EPDM rubber backing ensures sterile steam sealing prevents intrusion from the atmosphere and does not allow product residues to build up on the product contact surface. The product lines are separated by two seals and a sterile barrier chamber to prevent mixing the products and to ensure immediate indication in the event of leakage from one of the seals. Two small pneumatic normally open (NO) valves control flow to and from the sterile barrier chamber. The barrier chamber must be clean and sterile when the main valve is closed.

Standard design

The Alfa Laval SMP-BCA Mixproof Valve consists of valve bodies, bonnet, stem with diaphragm unit, PTFE EPDM or FPM plug seals and an actuator. The valve is assembled by means of clamp rings and a stem clip system for easy maintenance. It is also available as a shut-off valve. The valve



can also be fitted with the Alfa Laval ThinkTop V50 and V70 for sensing and control of the valve.

Technical Data

Temperature

Temperature range:	-10 °C to 140 °C / 14 °F to 284 °F (EPDM)
Max. sterilization temperature (steam - short time)	150 °C - 380 kPa (3.8 bar) / 302 °F - 55 psi (3.8 bar)

Pressure

Pressure range:	0-800 kPa (0-8 bar) / 0-116 psi (0-8 bar)
Optimum process conditions:	>50 kPa (0.5 bar), > 20 °C / >7.25 psi (0.5 bar), > 68 °F
Air pressure:	500-800 kPa (5-8 bar) / 72.5-116 psi (5-8 bar)



Vacuum is not recommended in aseptic applications.

Physical Data

Material

Product wetted steel parts:	1.4404 (316L)
External surface finish:	Semi-bright (blasted)
Internal surface finish:	Ra ≤ 1.6 µm / Ra < 64 µinch
Optional:	Bright (polished) Ra ≤ 0.8 µm / Ra ≤ 32 µinch
Other steel parts:	1.4301 (304)
Product wetted seals:	EPDM and PTFE
Optional:	NBR and PTFE, FPM and PTFE
Other seals:	NBR, EPDM

Valve body combination

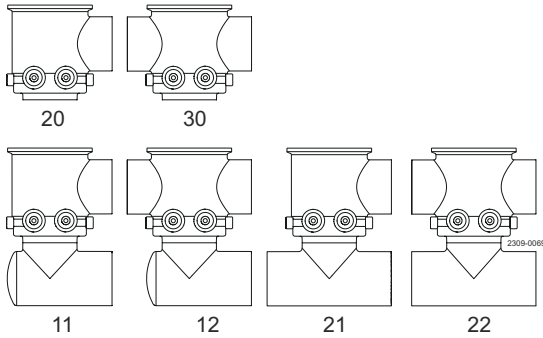

Type 20 and 30 body versions are on request available in following configurations:

- Tee welded on lower port in 0 or 90 deg. version. Type: 21 and 22
- Bend welded on lower port in 0, 90, 180 or 270 deg. version. Type: 11 and 12

Options

- Male parts or clamp ends in accordance with required standard
- Control and Indication: ThinkTop V50 and V70, IndiTop
- Larger actuator for valve sizes 38-51 mm/DN 40-50
- CIP installation kits
- Other valve body combinations
- Service tool for actuator
- Tool for plug seals (Necessary for changing the seals)



Note! For further details, see also instruction manual ESE02251.

Air consumption (litres free air)

Size	38 mm, 51 mm/DN40, 50 Actuator ø89	63.5, 76.1, 101.6 mm/DN65, 80, 100 Actuator ø133
Stop valve/Divert valve	0.2 x Air pressure (bar)	0.7 x Air pressure (bar)

Expected lifetime of diaphragm unit under normal conditions:
(no pressure shocks or cavitation)

Size/Type	Stop valve activations	Divert valve activations
38 mm/DN40	12,000	10,000
51 mm/DN50	12,000	10,000
63.5 mm/DN65	12,000	5,000
76.1 mm/DN80	5,000	5,000
101.6 mm/DN100	5,000	5,000



Note! Activating the valve without internal product pressure reduces lifetime of diaphragm unit.

Pressure drop/capacity diagrams

Stop valve:

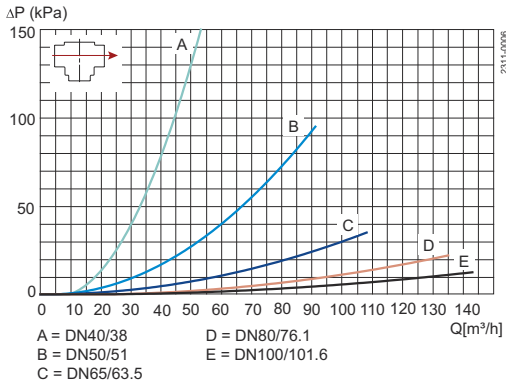

Divert valve (obsolete product):

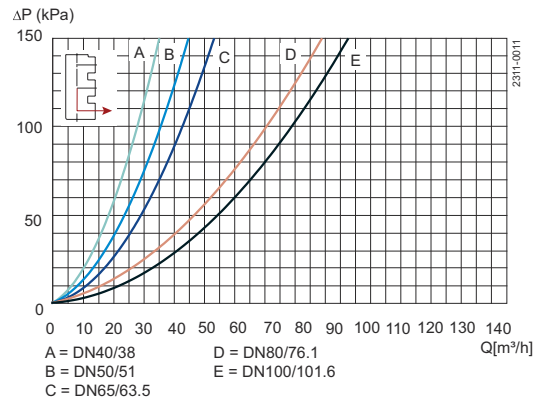
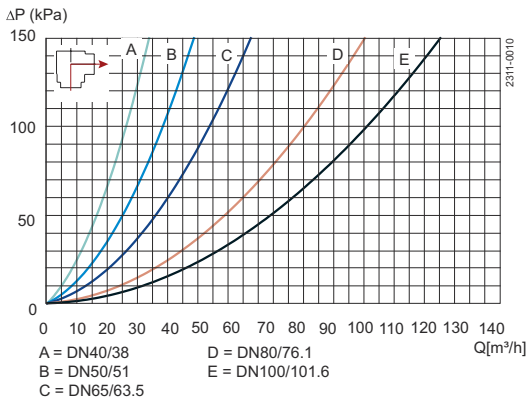
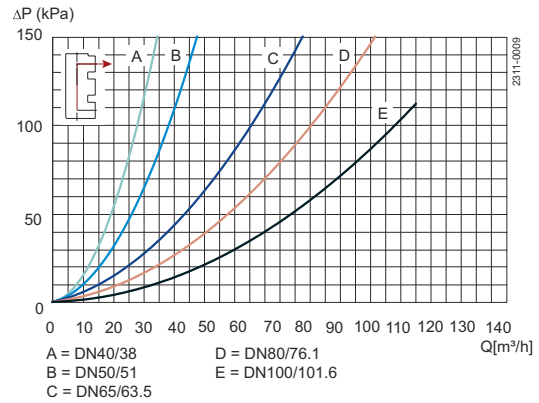
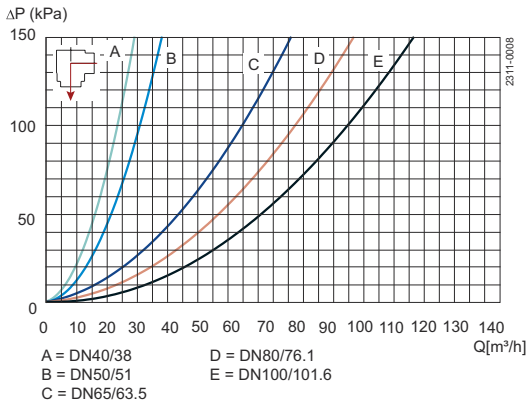
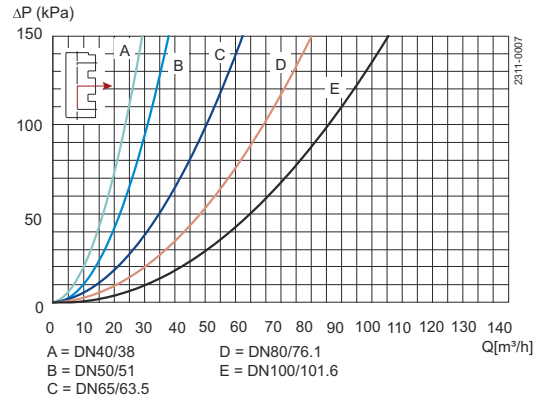

Note! For the diagrams the following applies:
 Medium: Water (20°C).
 Measurement: In accordance with VDI 2173.

CIP chamber:

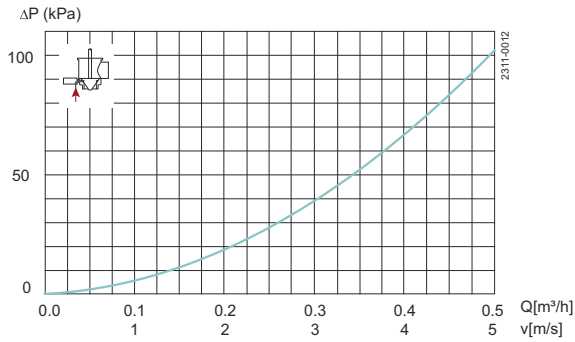

Divert valve (obsolete product):

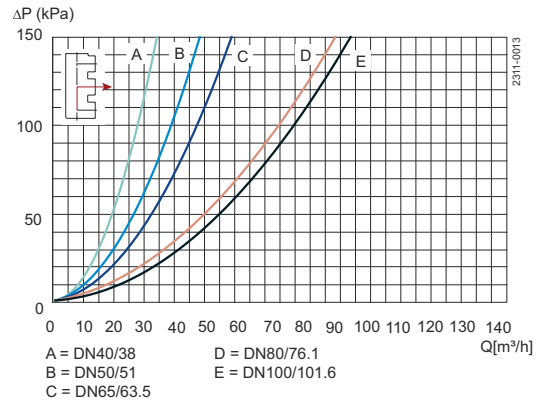

Note! For the diagrams the following applies:
 Medium: Water (20°C).
 Measurement: In accordance with VDI 2173.

Pressure data for SMP-BCA

1. Upper plug. Max. product pressure P1 without leakage due to pressure shocks, as a function of support air pressure.

Direction of pressure	Valve size	Actuator size	Spring type	Support air pressure (bar)	
				0	3
	38mm/ DN40	ø89	Normal	6.0	16.0
			Strong	9.6	19.5
			Normal	16.0	30.0
	51mm/ DN50	ø89	Normal	6.0	16.0
			Strong	9.6	19.5
			Normal	16.0	30.0
63.5mm/ DN65	ø133	Normal	9.6	25.5	
		Strong	16.0	30.0	
		Normal	6.5	14.5	
76.1mm/ DN80	ø133	Strong	9.2	17.5	
		Normal	4.0	11.0	
		Strong	6.5	14.4	
101.6mm/ DN100	ø133	Strong	6.5	14.4	

F1 = Spring + support Air

2. Upper plug. Max. product pressure P2 against which the valve can open, as a function of air pressure.

Direction of pressure	Valve size	Actuator size	Spring type	Support air pressure (bar)	
				3	4
	38mm/ DN40	ø89	Normal	8.0	8.0
			Strong	-	8.0
			Normal	8.0	8.0
	51mm/ DN50	ø89	Normal	8.0	8.0
			Strong	-	8.0
			Normal	8.0	8.0
	63.5mm/ DN65	ø133	Normal	4.0	8.0
			Strong	-	1.4
			Normal	2.8	7.0
	76.1mm/ DN80	ø133	Strong	-	2.0
			Normal	2.2	4.6
			Strong	-	1.6
101.6mm/ DN100	ø133	Strong	-	1.6	

3. Upper valve. Max. product pressure P3 in upper valve body at which the valve can close.

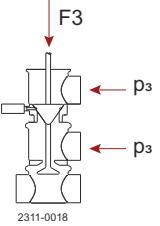
Direction of pressure	Valve size	Actuator size, spring type			
		ø89, Normal	ø89, Strong	ø133, Normal	ø133, Strong
 2311-0018	38mm/DN40	2.7	4.5	8.0	8.0
	51mm/DN50	2.4	4.0	6.0	8.0
	63.5mm/DN65	-	-	7.0	8.0
	76.1mm/DN80	-	-	7.0	8.0
	101.6mm/DN100	-	-	5.0	8.0

F2 = Air - spring

F3 = Spring



Note! If actuator is supported by air on spring side; max allowable pressure is 300 kPa (3 bar)

Air reduction valve: Alfa Laval item no. 9611995903 ensuring max 3 bar support air.

4. Lower valve, change-over. Max. product pressure P4 without leakage, as a function of air pressure.

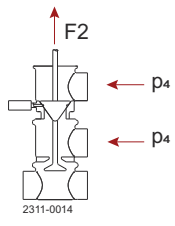
Direction of pressure	Valve size	Actuator size	Spring size	Air pressure (bar)
				3
 2311-0014	38mm/DN40	ø89	Normal	*
		ø89	Strong	*
	51mm/DN50	ø133	Normal	8.6
		ø133	Strong	*
		ø89	Normal	*
		ø89	Strong	*
	63.5mm/DN65	ø133	Normal	8.6
		ø133	Strong	*
		ø133	Normal	3.4
		ø133	Strong	*
	76.1mm/DN80	ø133	Normal	*
		ø133	Strong	*
		ø133	Normal	*
		ø133	Strong	*
101.6mm/DN100	ø133	Normal	*	
	ø133	Strong	*	

* = Valve cannot close

5. Upper valve. Max. CIP pressure PCIP without leakage to product area as a function of product pressure below plug.

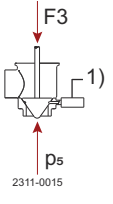
Direction of pressure	Valve size	Actuator size	Spring size	Product pressure P ₅ below plug (bar)		
				0	2	4
 2311-0015	38mm/DN40	ø89	Normal	9.0	6.3	3.5
		ø89	Strong	10.0	9.9	7.2
	51mm/DN50	ø133	Normal	10.0	10.0	10.0
		ø133	Strong	10.0	10.0	10.0
		ø89	Normal	9.0	6.3	3.5
		ø89	Strong	10.0	9.6	6.7
	63.5mm/DN65	ø133	Normal	10.0	10.0	10.0
		ø133	Strong	10.0	10.0	10.0
		ø133	Normal	10.0	10.0	9.3
		ø133	Strong	10.0	10.0	10.0
	76.1mm/DN80	ø133	Normal	10.0	10.0	8.5
		ø133	Strong	10.0	6.8	2.3
		ø133	Normal	10.0	6.0	-
		ø133	Strong	10.0	10.0	6.5

F2 = Air - spring

F3 = Spring



Note! Max. recommended CIP pressure = 100 kPa (1 bar).

If actuator is supported by air on spring side; max allowable pressure is 300 kPa (3 bar)

Dimensions (mm)

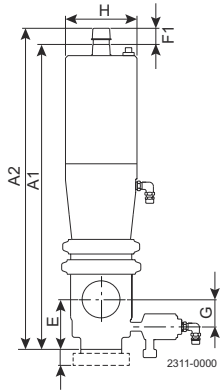

Figure 1. a. Stop valve

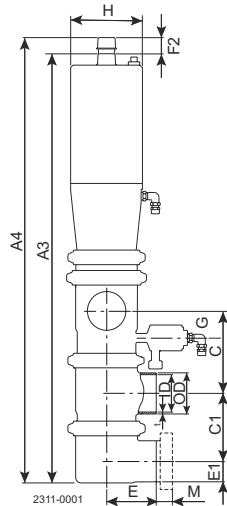
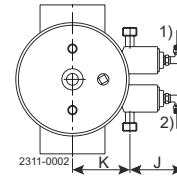

Figure 2. b. Divert valve (obsolete products)



- 1) CIP valve
- 2) Detecting valve

Figure 3. c. Top view 1) CIP valve - 2) Detecting valve

Size	38	51	63.5	76.1	101.6	40	50	65	80	100
	mm	mm	mm	mm	mm	DN	DN	DN	DN	DN
A ₁	371	381	459	481	553	369	379	456	482	552
A ₂	385	395	473	501	573	383	393	470	502	572
A ₃	511	532	642	677	778	511	532	642	693	778
A ₄	525	546	662	697	798	525	546	662	713	798
C	90	102	124	129	157	90	102	124	134	157
C ₁	80	84	108	115	150	80	84	108	120.5	150
OD	38	50.8	63.5	76.1	101.6	41	53	70	85	104
ID	34.9	47.6	60.3	72.1	97.6	38	50	66	81	100
t	1.6	1.6	1.6	2.0	2.0	1.5	1.5	2.0	2.0	2.0
E	49.5	61.5	82.3	87.3	133.5	49.5	61.5	82.3	87.3	133.5
E ₁	20.5	26.8	33.2	39.1	51.8	22	28	36	43.5	53
F ₁	14	14	14	20	20	14	14	14	20	20
F ₂	14	14	20	20	20	14	14	20	20	20
G	27	33.3	39.7	45.6	58.3	28.5	34.5	42.5	50	59.5
H	89	89	89	133	133	89	89	89	133	133
J	46.7	46.7	57	66.6	84.3	46.7	46.7	57	66.6	84.3
K	63	63	63	63	63	63	63	63	63	63
M/ISO	clamp	21	21	21	21					
M/ISO	male	21	21	21	21					
M/DIN	male					22	23	25	25	30
M/SMS	male	20	20	24	24	35				
M/BS	male	22	22	22	22	27				
Weight (kg):	Stop valve	6.5	6.8	13.3	14.9	18.2	6.5	6.8	13.3	15.6
	Divert valve	8.2	8.6	15.5	18.6	24.6	8.2	8.6	15.5	19.6

Air Connections Compressed air:
R 1/8" (BSP), internal thread.

CIP connection:
R 3/8" (BSP), external thread.

Leakage connection:
R 3/8" (BSP), external thread.

Caution, opening/closing time:

Opening/closing time will be affected by the following:

- The air supply (air pressure)
- The length and dimensions of the air hoses
- Number of valves connected to the same air hose
- Use of single solenoid valve for serial connected air actuator functions
- Product pressure

This document and its contents are subject to copyrights and other intellectual property rights owned by Alfa Laval AB (publ) or any of its affiliates (jointly "Alfa Laval"). No part of this document may be copied, re-produced or transmitted in any form or by any means, or for any purpose, without Alfa Laval's prior express written permission. Information and services provided in this document are made as a benefit and service to the user, and no representations or warranties are made about the accuracy or suitability of this information and these services for any purpose. All rights are reserved.

How to contact Alfa Laval

Up-to-date Alfa Laval contact details for all countries are always available on our website at www.alfalaval.com