

### FRAME PLATE

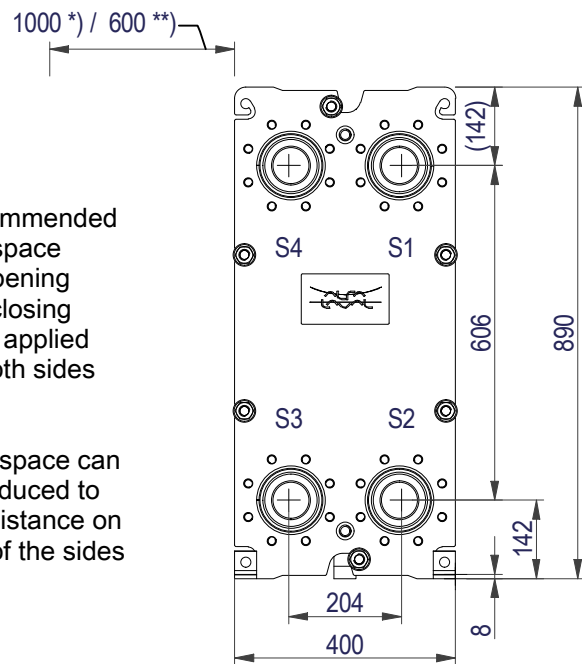

\*) Recommended free space for opening and closing to be applied on both sides

\*\*) Free space can be reduced to this distance on one of the sides

Space between pressure plate and supporting column should be kept free from fixed installations!

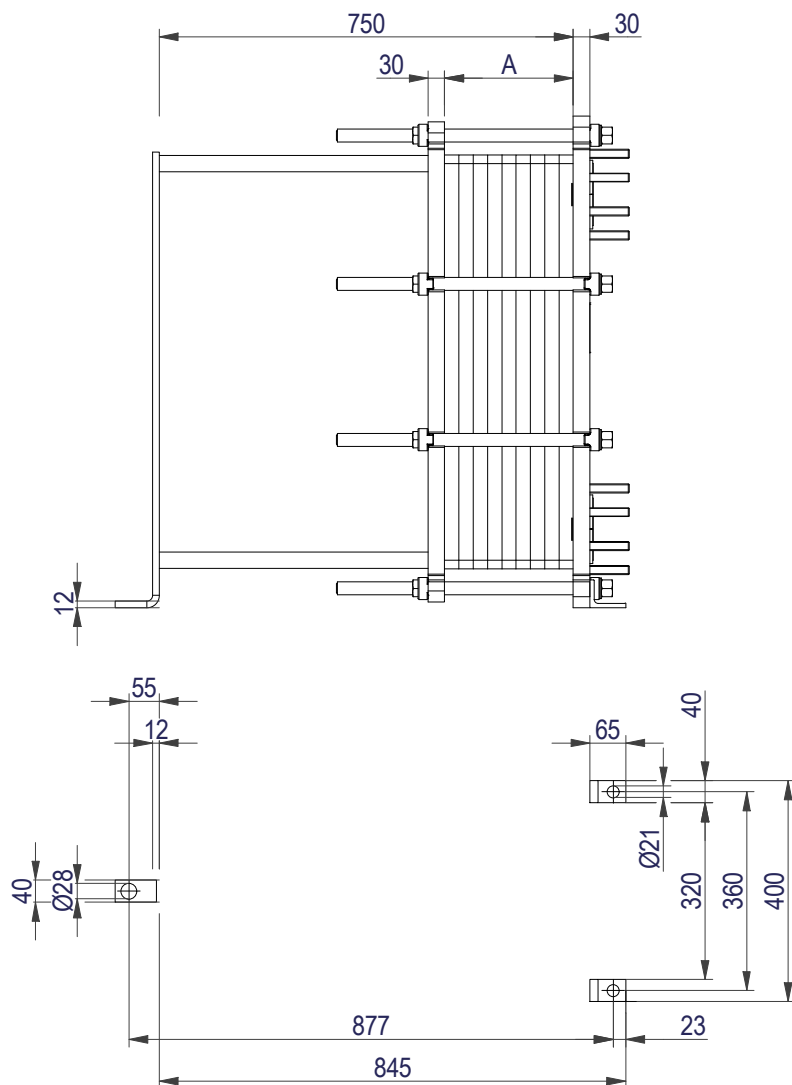

### PRESSURE PLATE (MOVABLE)

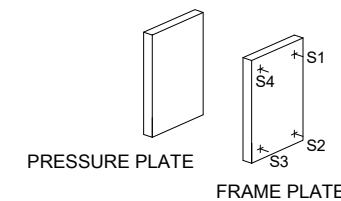
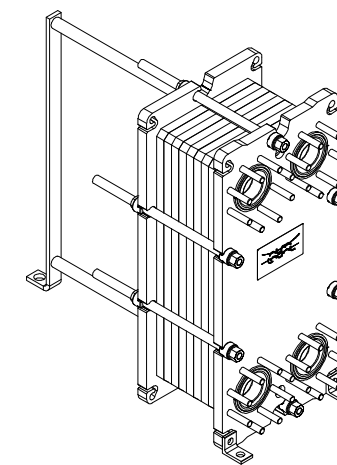
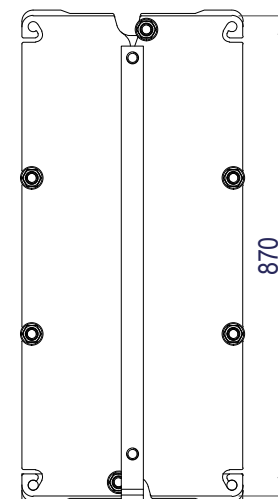

EN 1092-1 DN80 PN10  
S1, S2, S3, S4

A-A:  
NBRP / ALLOY 316

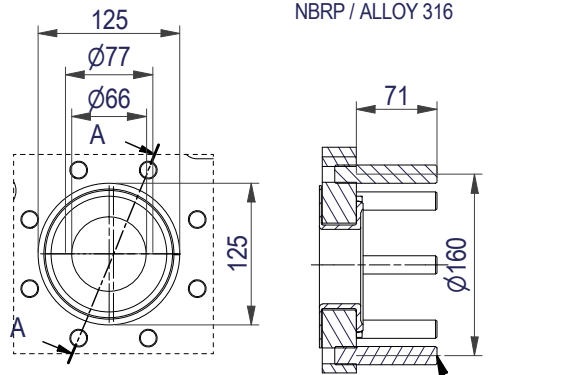

All dimensions in millimeters (mm)

NO. OF UNITS

1

#### APPROX. OUTER DIMENSIONS

LENGTH 870 mm  
WIDTH 410 mm  
HEIGHT 900 mm

#### APPROX. WEIGHTS

NET WEIGHT, EMPTY 274 kg  
WEIGHT FULL OF WATER 317 kg  
PLATE MATERIAL ALLOY 316  
PLATE THICKNESS 0.5 mm  
GASKET NBRP ClipGrip™

CHANNEL ARRANGEMENT 1\*50 L / 1\*49 L



www.alfalaval.com

DRAWING  
GASKETED PLATE HEAT EXCHANGER

# T8-BFM

PED Article 4.3

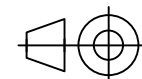

8240118507

Do not use this drawing for foundation bolting or piping layout

DATE 2/16/22  
REVISION 0

This document and its contents are subject to copyrights and other intellectual property rights owned by Alfa Laval (pub) or any of its affiliates (Alfa Laval). No part of this document may be copied, reproduced or transmitted in any form or by any means, or for any purpose, without Alfa Laval's prior express written permission. Information and services provided in this document are made as a benefit and service to the user, and no representations or warranties are made about the accuracy or suitability of this information and these services for any purpose. All rights are reserved.