

This document and its contents are subject to copyrights and other intellectual property rights owned by Alfa Laval (pub) or any of its affiliates (Alfa Laval). No part of this document may be copied, reproduced or transmitted in any form or by any means, or for any purpose, without Alfa Laval's prior express written permission. Information and services provided in this document are made as a benefit and service to the user, and no representations or warranties are made about the accuracy or suitability of this information and these services for any purpose. All rights are reserved.

**PRESSURE PLATE**  
(MOVABLE)

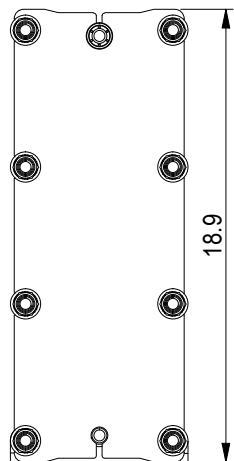

Space between pressure plate and supporting column should be kept free from fixed installations!

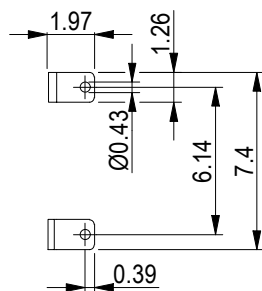
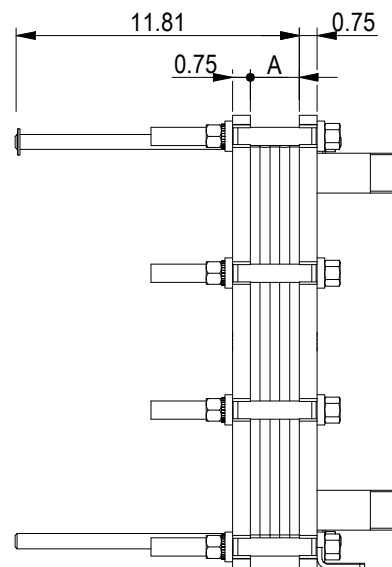

ASME B1.20.1 - 1 1/4-11.5 NPT, ALLOY 316, 101 mm  
S1, S2, S3, S4 A-A:

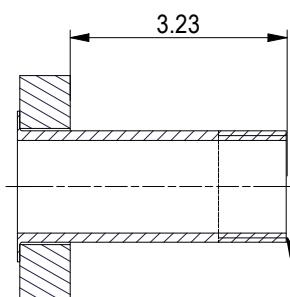
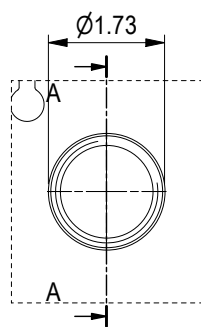

ASME B1.20.1 - 1 1/4-11.5 NPT

NO. OF UNITS 1

20.0 GPM  
20.0 GPM

**FRAME PLATE**

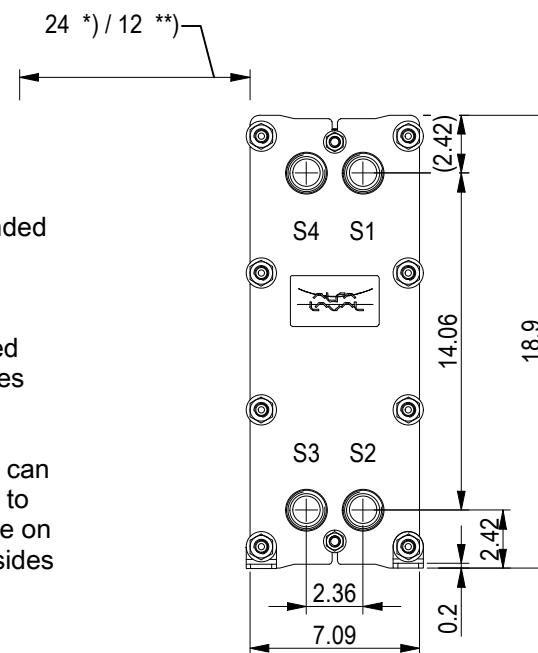

\*) Recommended free space for opening and closing to be applied on both sides

\*\*) Free space can be reduced to this distance on one of the sides

All dimensions in inches

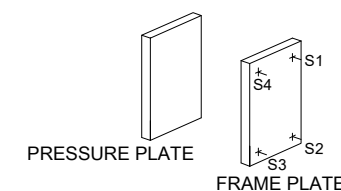
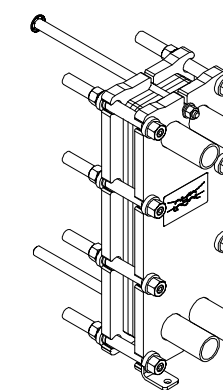

TIGHTENING BOLTS 4 x M16, L = 7.1 in  
4 x M16, L = 7.1 in

APPROX. OUTER DIMENSIONS  
LENGTH 15.4 in  
WIDTH 7.5 in  
HEIGHT 19.3 in  
APPROX. WEIGHTS  
NET WEIGHT, EMPTY 77.2 lb  
WEIGHT FULL OF WATER 81.3 lb  
PLATE MATERIAL ALLOY 316  
PLATE THICKNESS 0.5 mm  
GASKET NBRP Clip-on  
AREA OF HEAT SURFACE 6.2 ft<sup>2</sup>



www.alfalaval.com

DRAWING  
GASKETED PLATE HEAT EXCHANGER  
**M3-FG**

ASME  
Code Section VIII Div.1

MAWP 150 psi at 266.0 °F  
MDMT -18.0 °F at 150 psi  
Designed, constructed and stamped in accordance with 2021 ASME.

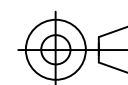

8240171381  
M3-FG-20 Plates

Do not use this drawing for foundation bolting or piping layout  
or planning of lifting and handling of the equipment.

DATE 6/12/23  
REVISION 0