

Note that all unique customer requirements (i.e tolerance) need to be verified thru Alfa Laval.

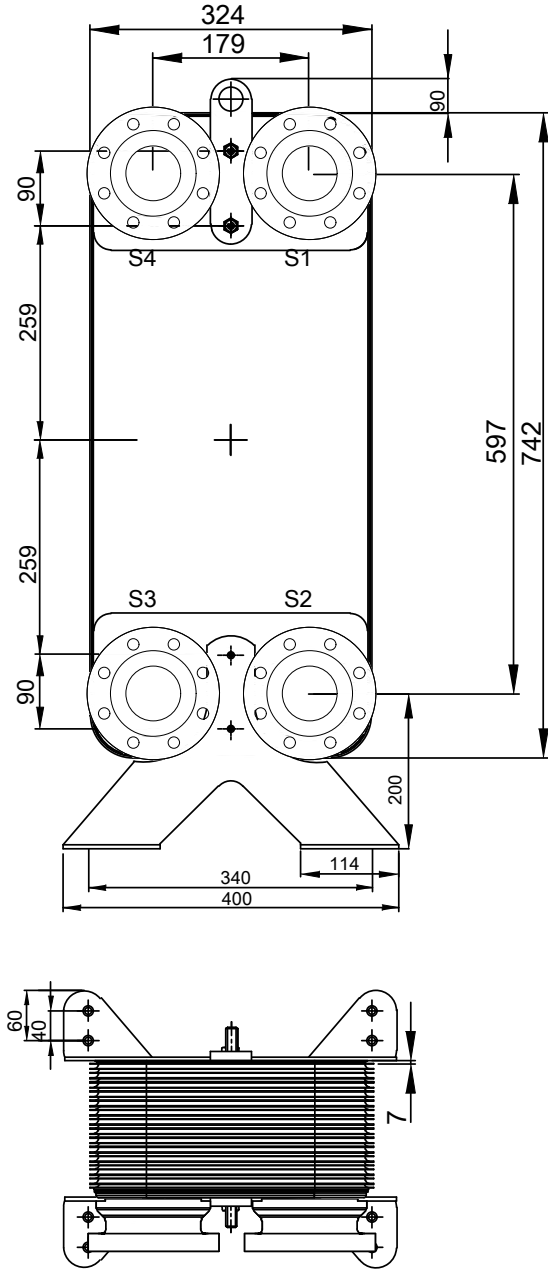
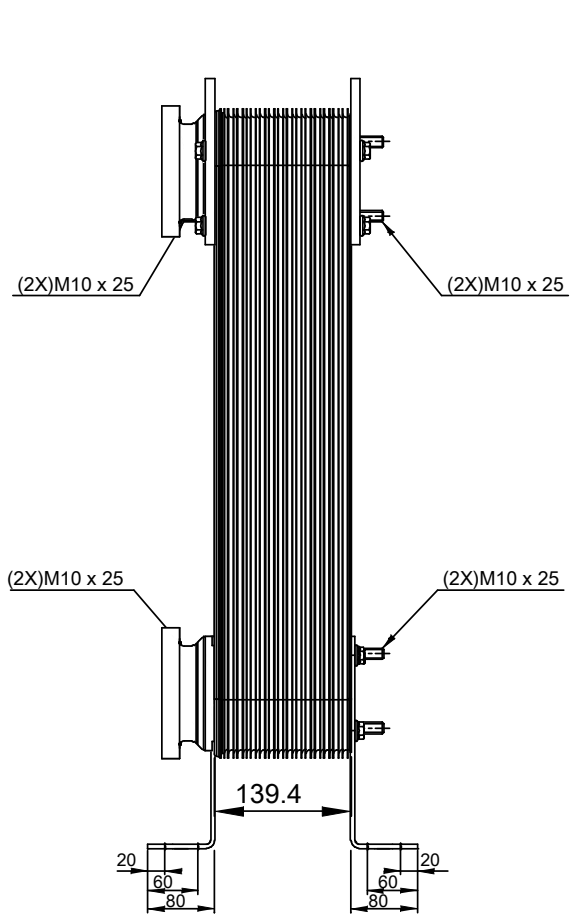
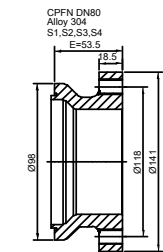

T1 T2 T3 T4 locations on back side correspond to S1 S2 S3 S4 on front side

HEATING SURFACE
 NETWEIGHT 58.1 kg
 OPERATING WEIGHT kg
 PLATE MATERIAL ALLOY 316
 PLATE GROUPING 1*29AHH/1*30AHL

ALL DIMENSIONS IN MILLIMETERS

SIDE	MEDIA	INLET	TEMP.	OUTLET	TEMP.	FLOW RATE	PRESSURE DROP	LIQUID VOL.
1		S1		S2				19.1 dm ³
2		S3		S4				12.1 dm ³

PRESSURE VESSEL APPROVAL PED/UK
 CB210-60AH-F (3075037790)



www.alfalaval.com

CUSTOMER NAME / REF. NO.	TOTAL LENGTH	299.4 mm
	TOTAL WIDTH	324.0 mm
COMPANY / REF.	TOTAL HEIGHT	959.0 mm
4/16/2024 REV 0		