

Note that all unique customer requirements (i.e tolerance) need to be verified thru Alfa Laval.

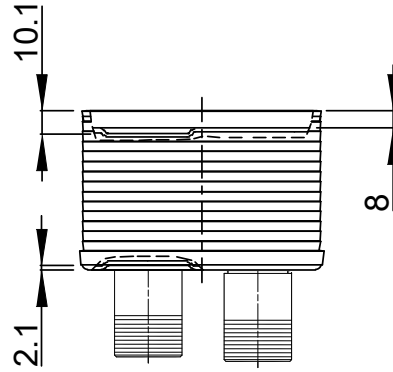
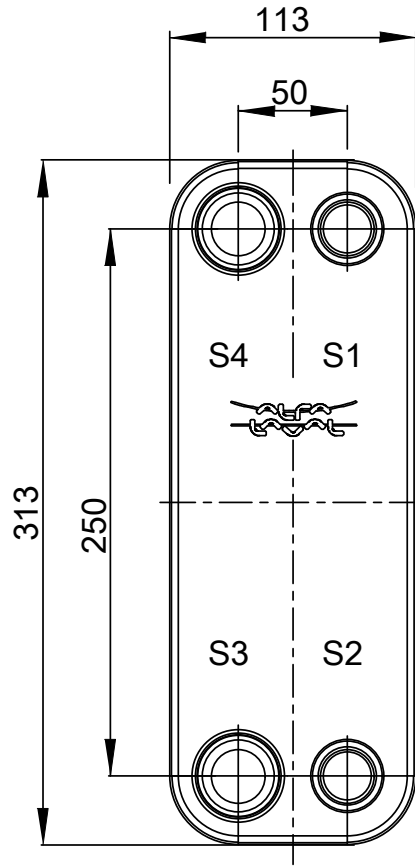
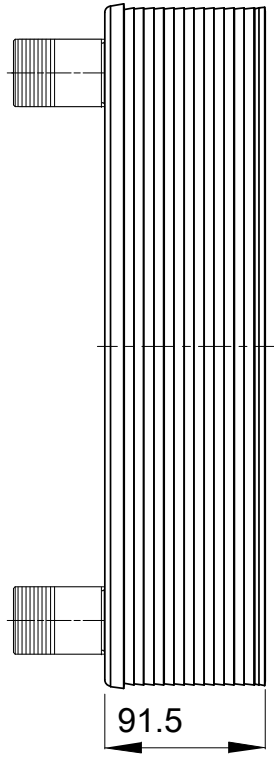
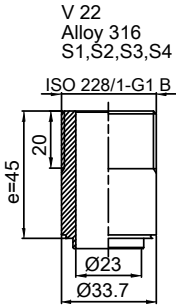

HEATING SURFACE
 NETWEIGHT 5.6 kg
 OPERATING WEIGHT kg
 PLATE MATERIAL ALLOY 316
 PLATE GROUPING 1*16H/1*17H

T1 T2 T3 T4 locations on back side correspond to S1 S2 S3 S4 on front side

ALL DIMENSIONS IN MILLIMETERS

| SIDE | MEDIA | INLET | TEMP. | OUTLET | TEMP. | FLOW RATE | PRESSURE DROP | LIQUID VOL. |
|------|-------|-------|-------|--------|-------|-----------|---------------|----------------------|
| 1 | | S1 | | S2 | | | | 0.92 dm ³ |
| 2 | | S3 | | S4 | | | | 0.86 dm ³ |

PRESSURE VESSEL APPROVAL

PED

CB30-34H (3287083387)

www.alfalaval.com

CUSTOMER NAME / REF. NO.

COMPANY / REF.

TOTAL LENGTH 136.5 mm
 TOTAL WIDTH 113.0 mm
 TOTAL HEIGHT 313.0 mm

1/15/2024
 REV 0