

Note that all unique customer requirements (i.e tolerance) need to be verified thru Alfa Laval.

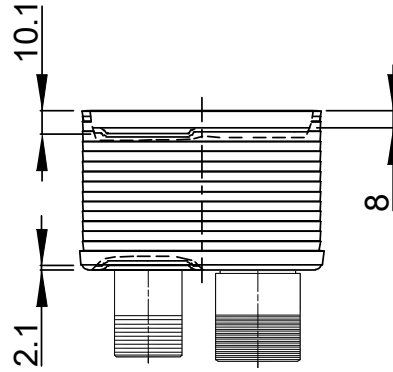
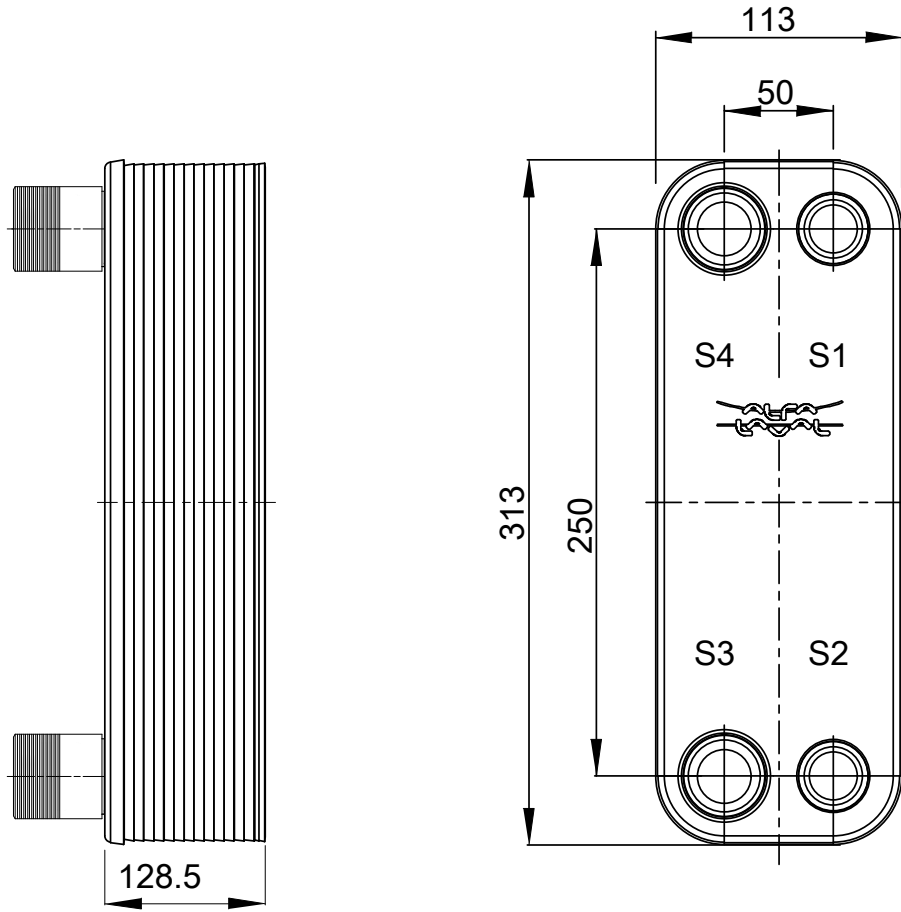
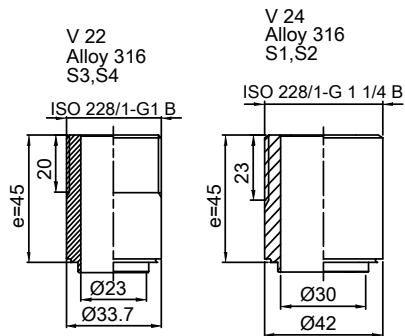

HEATING SURFACE  
 NETWEIGHT 7.5 kg  
 OPERATING WEIGHT kg  
 PLATE MATERIAL ALLOY 316  
 PLATE GROUPING 1\*24H/1\*25H

T1 T2 T3 T4 locations on back side correspond to S1 S2 S3 S4 on front side

ALL DIMENSIONS IN MILLIMETERS

SIDE	MEDIA	INLET	TEMP.	OUTLET	TEMP.	FLOW RATE	PRESSURE DROP	LIQUID VOL.
1		S1		S2				1.35 dm <sup>3</sup>
2		S3		S4				1.30 dm <sup>3</sup>



PRESSURE VESSEL APPROVAL

PED

CB30-50H (3287083364)

www.alfalaval.com

CUSTOMER NAME / REF. NO.

COMPANY / REF.

TOTAL LENGTH 173.5 mm  
 TOTAL WIDTH 113.0 mm  
 TOTAL HEIGHT 313.0 mm



1/15/2024  
 REV 0