

Note that all unique customer requirements (i.e tolerance) need to be verified thru Alfa Laval.

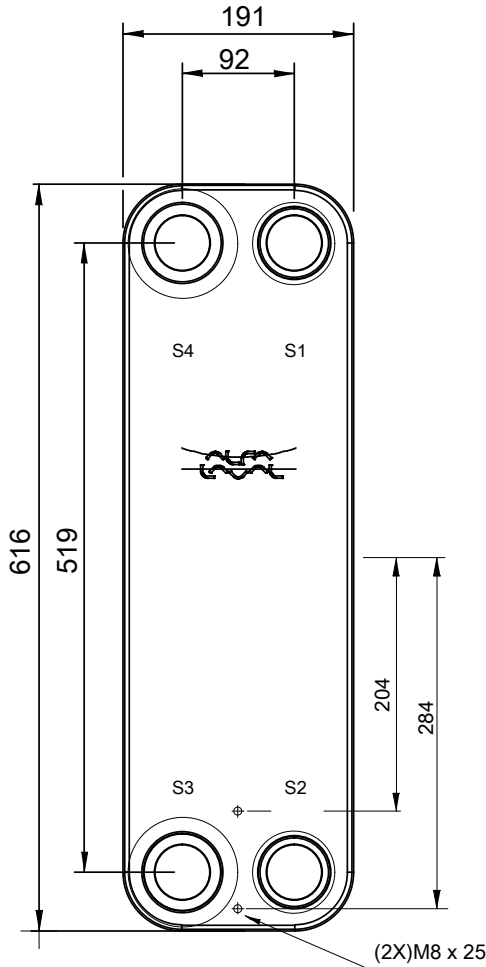
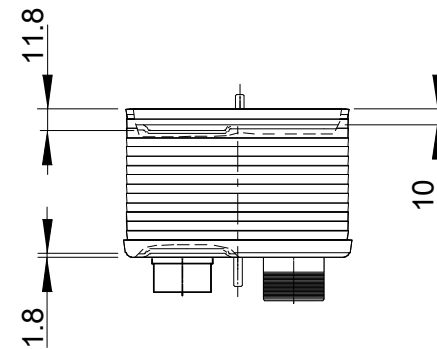
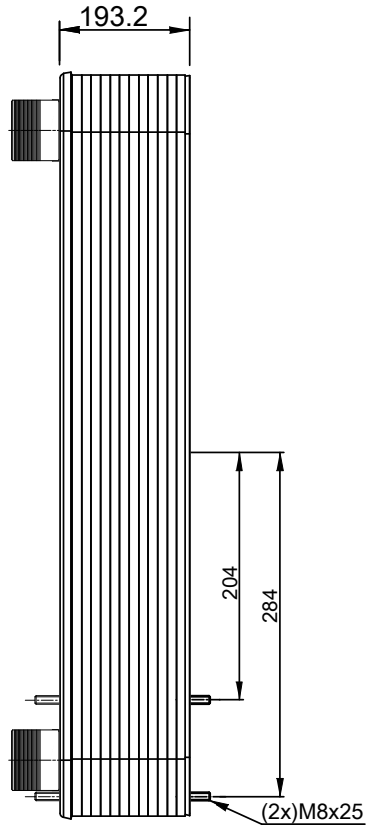
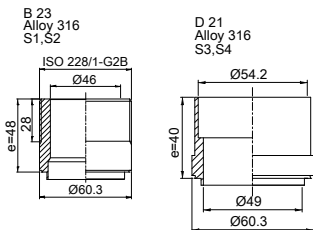

HEATING SURFACE
NETWEIGHT 36.1 kg
OPERATING WEIGHT kg
PLATE MATERIAL ALLOY 316
PLATE GROUPING 1*42AMH/1*43AML

T1 T2 T3 T4 locations on back side correspond to S1 S2 S3 S4 on front side

ALL DIMENSIONS IN MILLIMETERS

SIDE	MEDIA	INLET	TEMP.	OUTLET	TEMP.	FLOW RATE	PRESSURE DROP	LIQUID VOL.
1		S1		S2				8.60 dm ³
2		S3		S4				6.72 dm ³

PRESSURE VESSEL APPROVAL

PED

CB112-86AM (3287118405)

www.alfalaval.com

CUSTOMER NAME / REF. NO.

TOTAL LENGTH 260.2 mm
TOTAL WIDTH 191.0 mm
TOTAL HEIGHT 616.0 mm

COMPANY / REF.



1/15/2024
REV 0