

Note that all unique customer requirements (i.e tolerance) need to be verified thru Alfa Laval.

B 23
Alloy 316
S3,S4

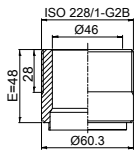

O 4
Alloy 316
S1,S2

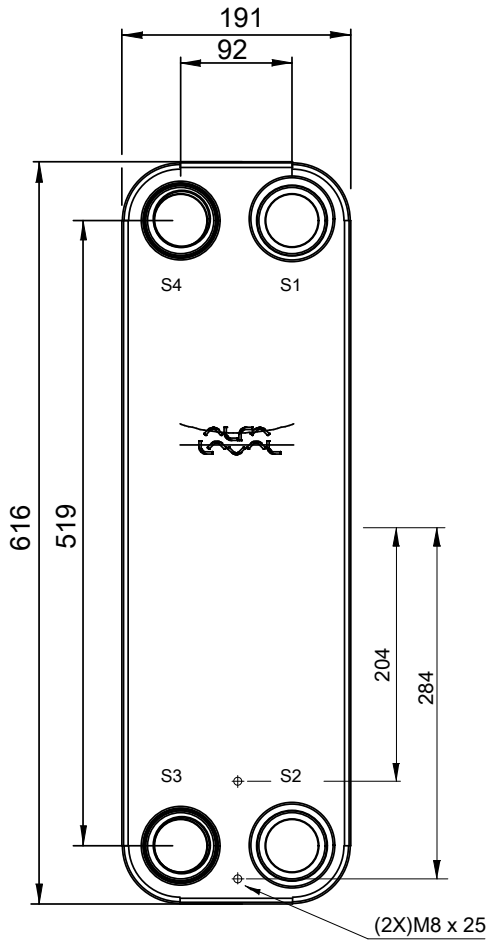
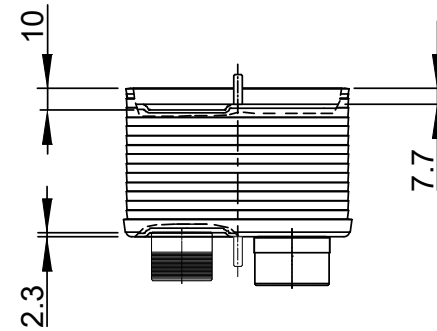
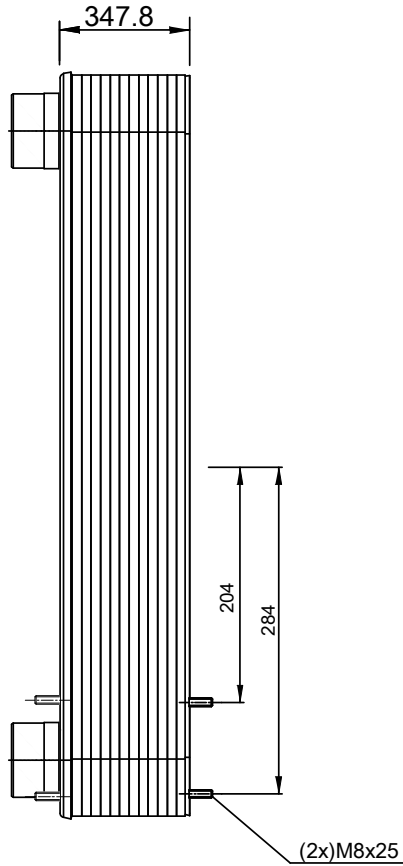
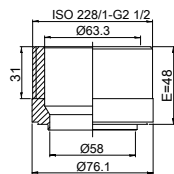

HEATING SURFACE
NETWEIGHT 56.9 kg
OPERATING WEIGHT kg
PLATE MATERIAL ALLOY 316
PLATE GROUPING 1*64L/1*65L

ALL DIMENSIONS IN MILLIMETERS

SIDE	MEDIA	INLET	TEMP.	OUTLET	TEMP.	FLOW RATE	PRESSURE DROP	LIQUID VOL.
1		S1		S2				13.7 dm ³
2		S3		S4				13.4 dm ³

PRESSURE VESSEL APPROVAL

PED

CB110-130L (3287132311)

www.alfalaval.com

CUSTOMER NAME / REF. NO.

TOTAL LENGTH 410.8 mm
TOTAL WIDTH 191.0 mm
TOTAL HEIGHT 616.0 mm

COMPANY / REF.



4/16/2024
REV 0